

# Trade in Value-Added

## A new perspective of international trade

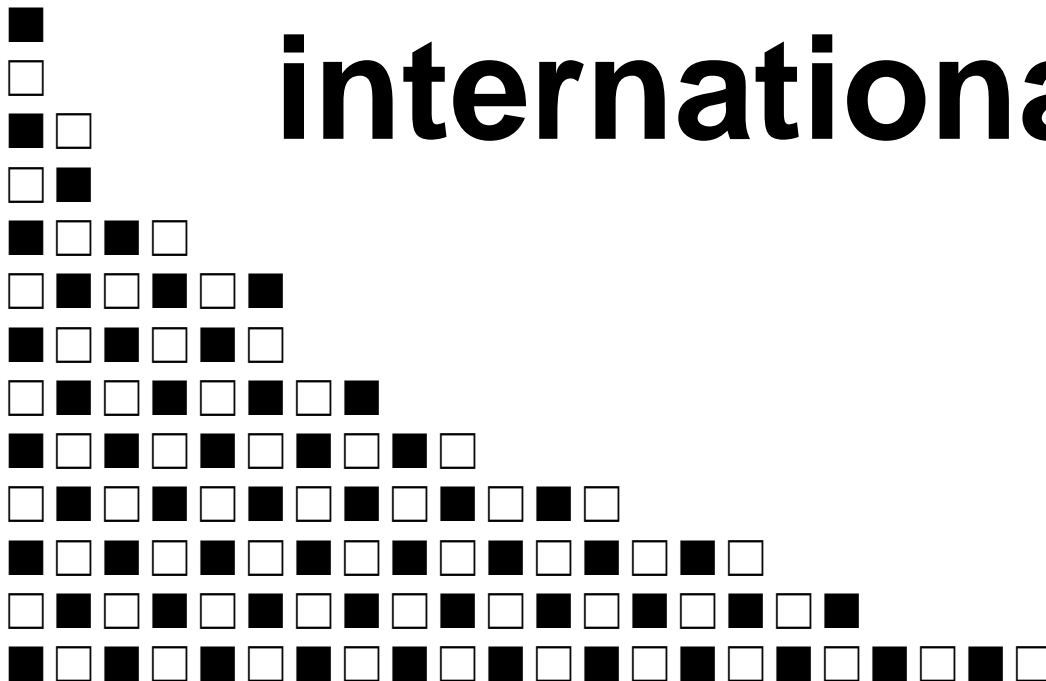

Satoshi Inomata  
IDE-JETRO



WORLD TRADE  
ORGANIZATION

IDE-JETRO

# Trade patterns and global value chains in East Asia:

## From trade in goods to trade in tasks



# Evolution of cross-national production networks in the Asia-US region

# 1985

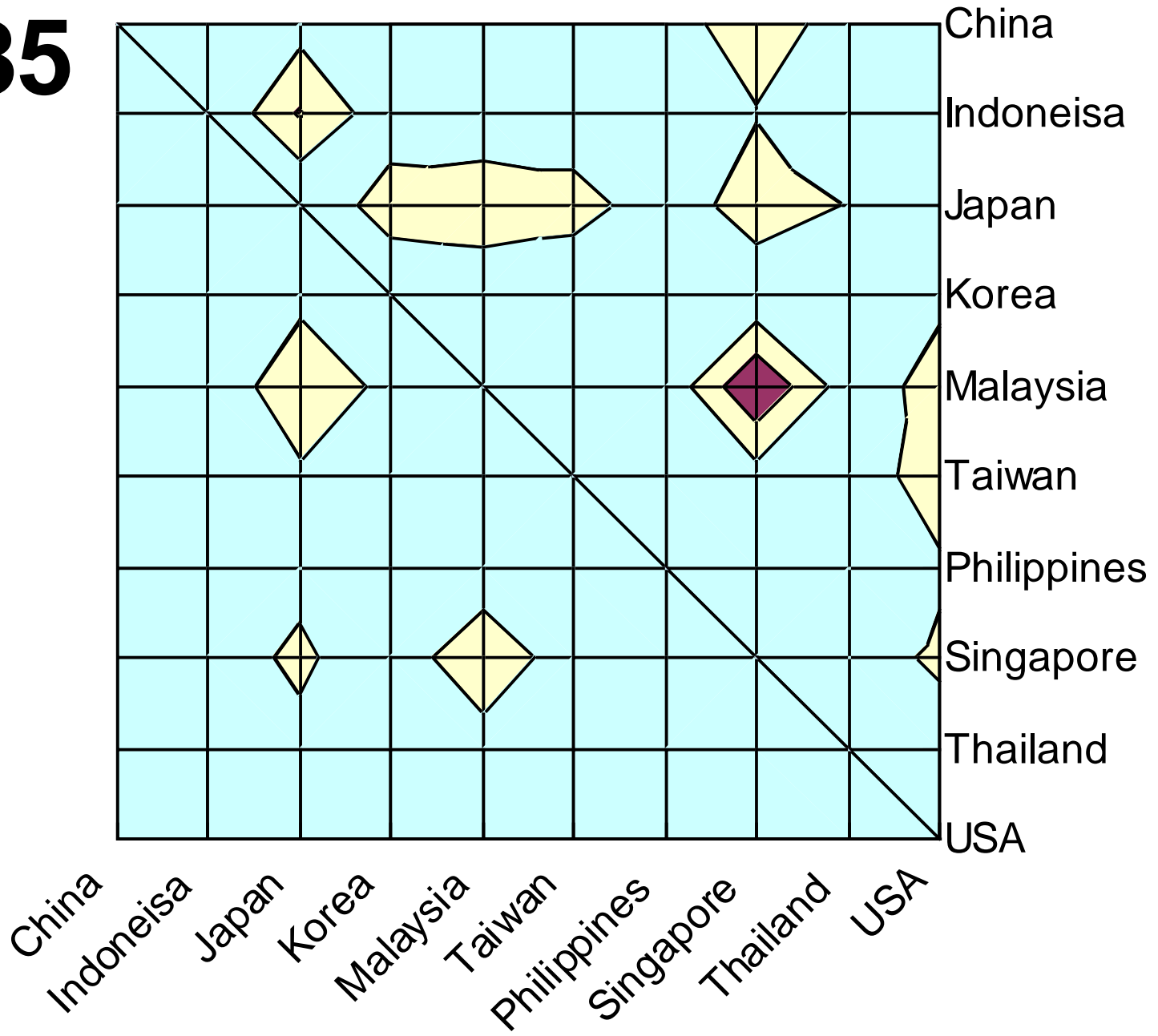

# 1995

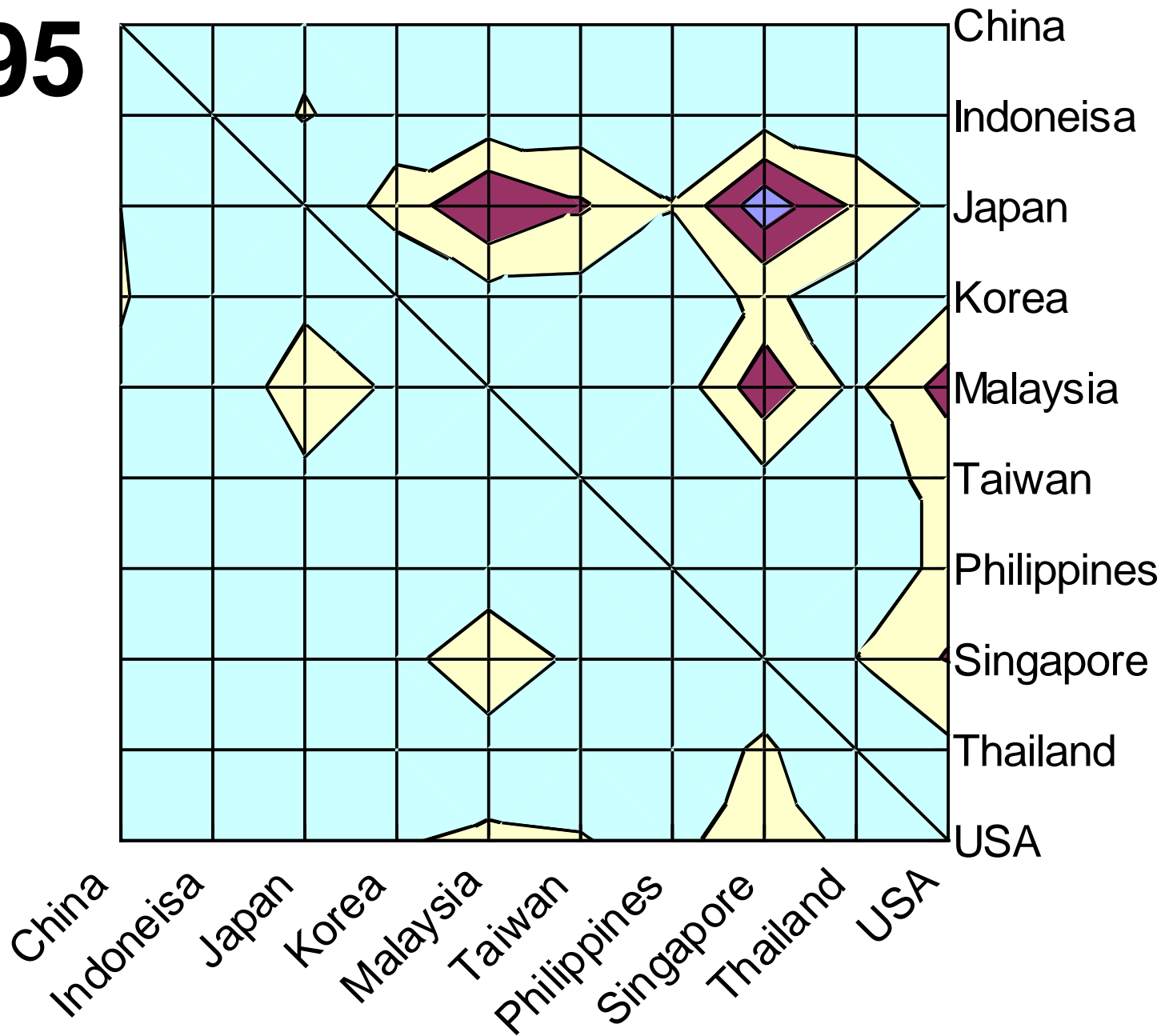



# 2005

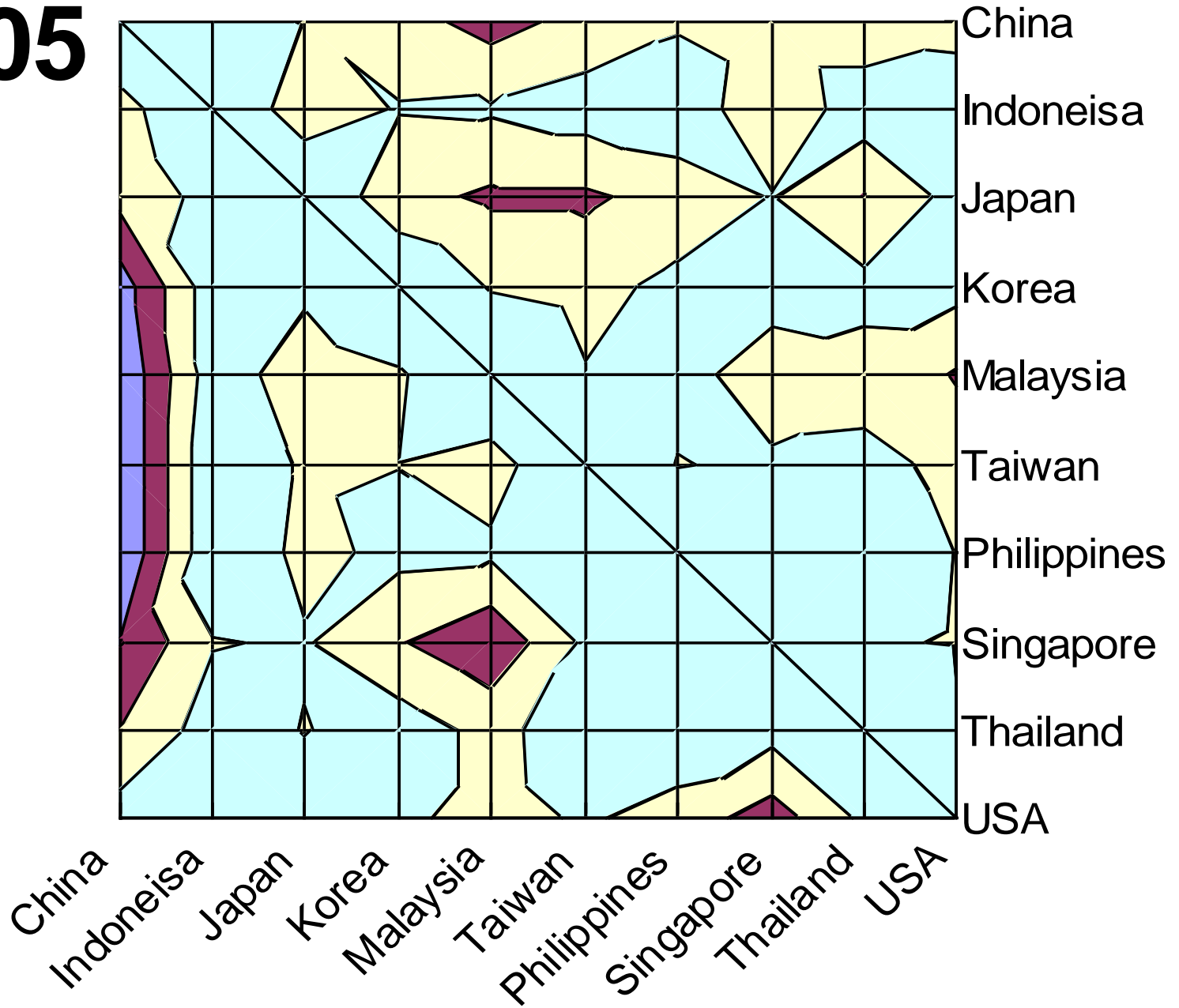

**1985**

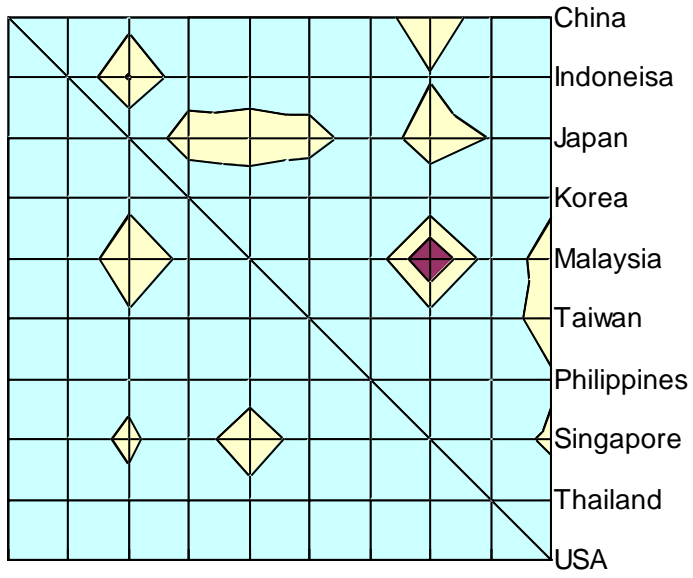

**1995**

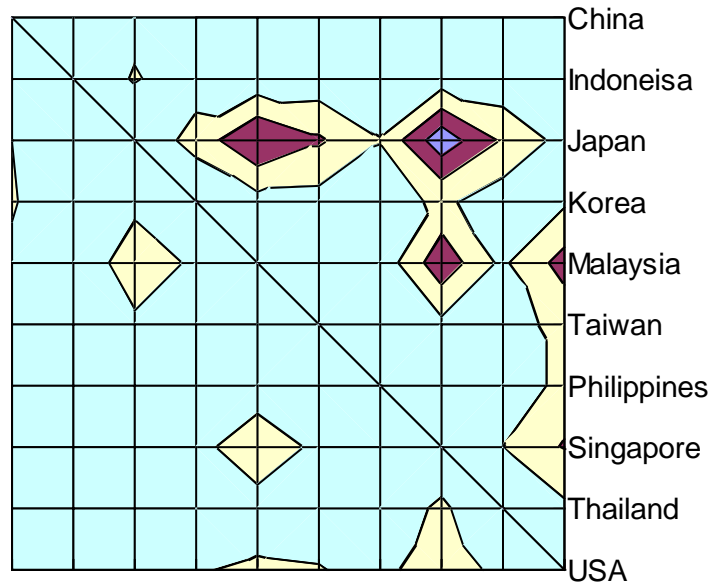

**2000**

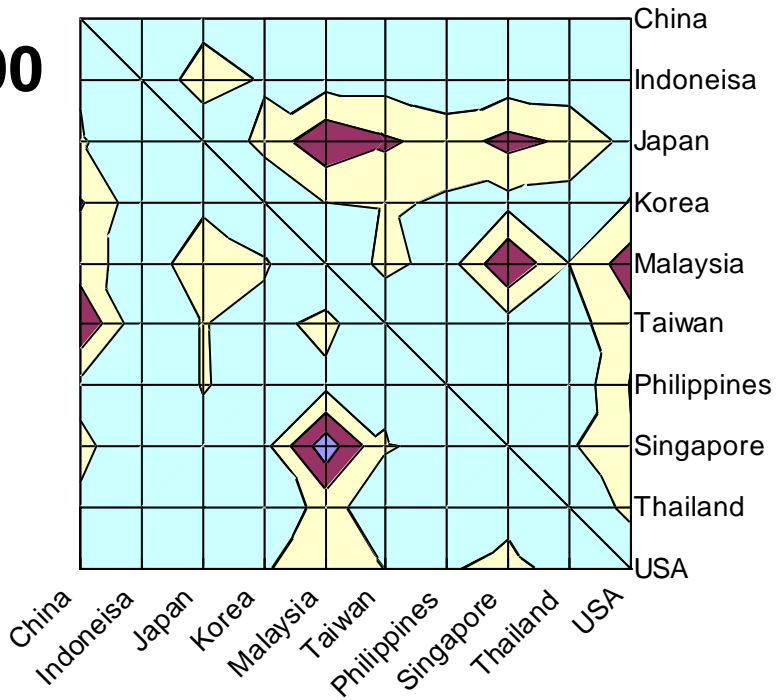

**2005**

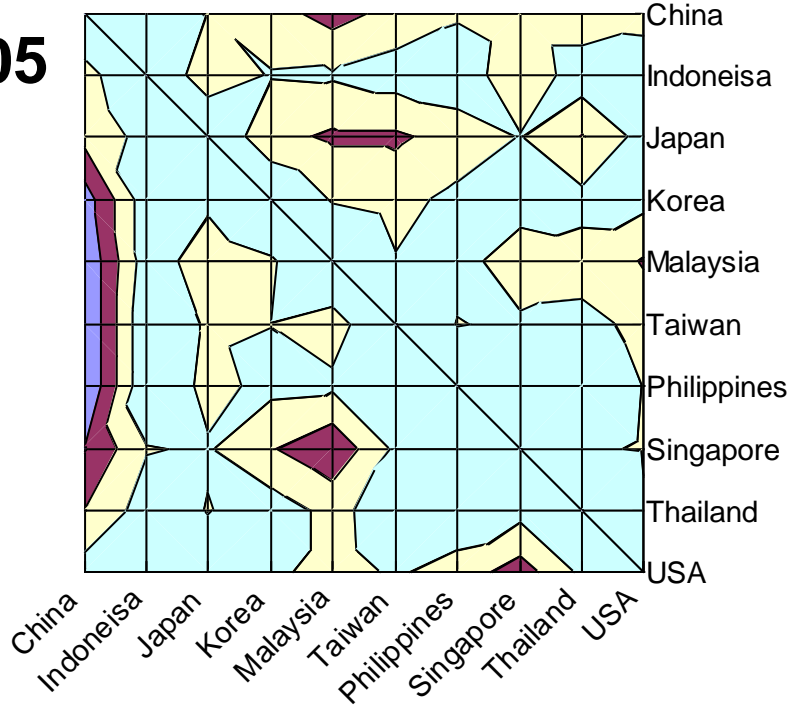





# 1986

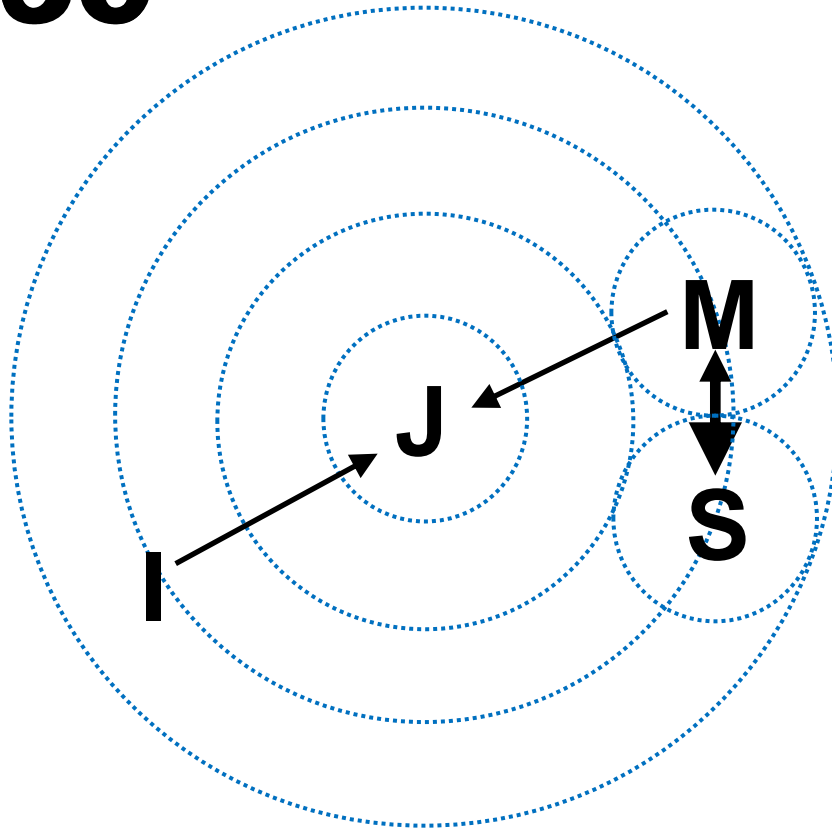

**C:** China, **I:** Indonesia, **J:** Japan, **K:** Korea,  
**M:** Malaysia, **N:** Taiwan, **P:** The Philippines,  
**S:** Singapore, **T:** Thailand, **U:** The USA

# 1996

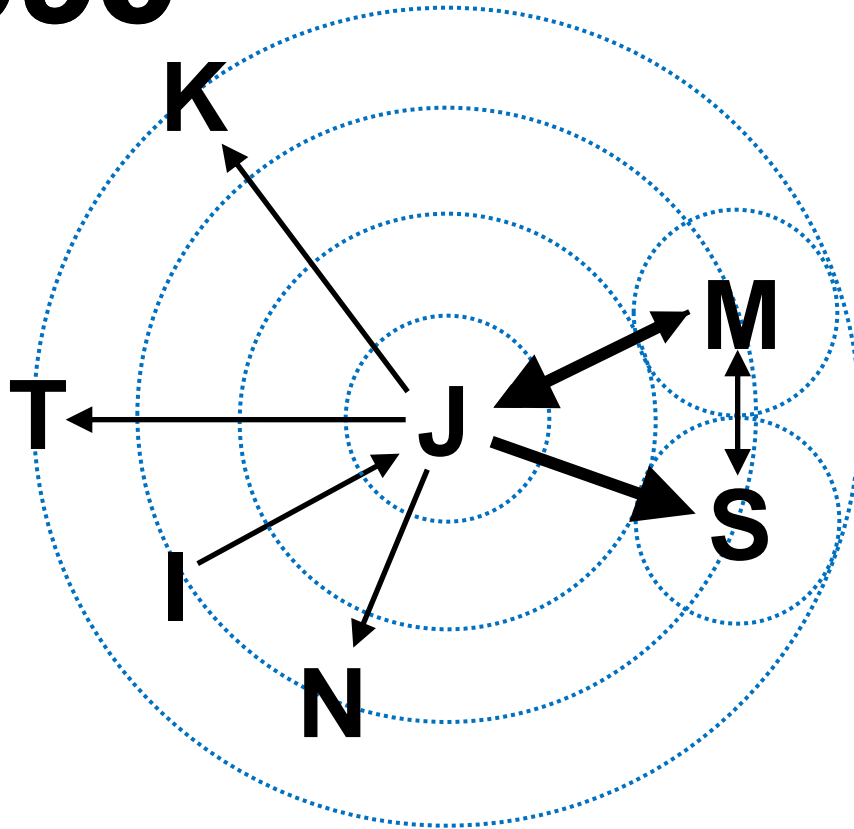

**C**: China, **I**: Indonesia, **J**: Japan, **K**: Korea,  
**M**: Malaysia, **N**: Taiwan, **P**: The Philippines,  
**S**: Singapore, **T**: Thailand, **U**: The USA

# 2006

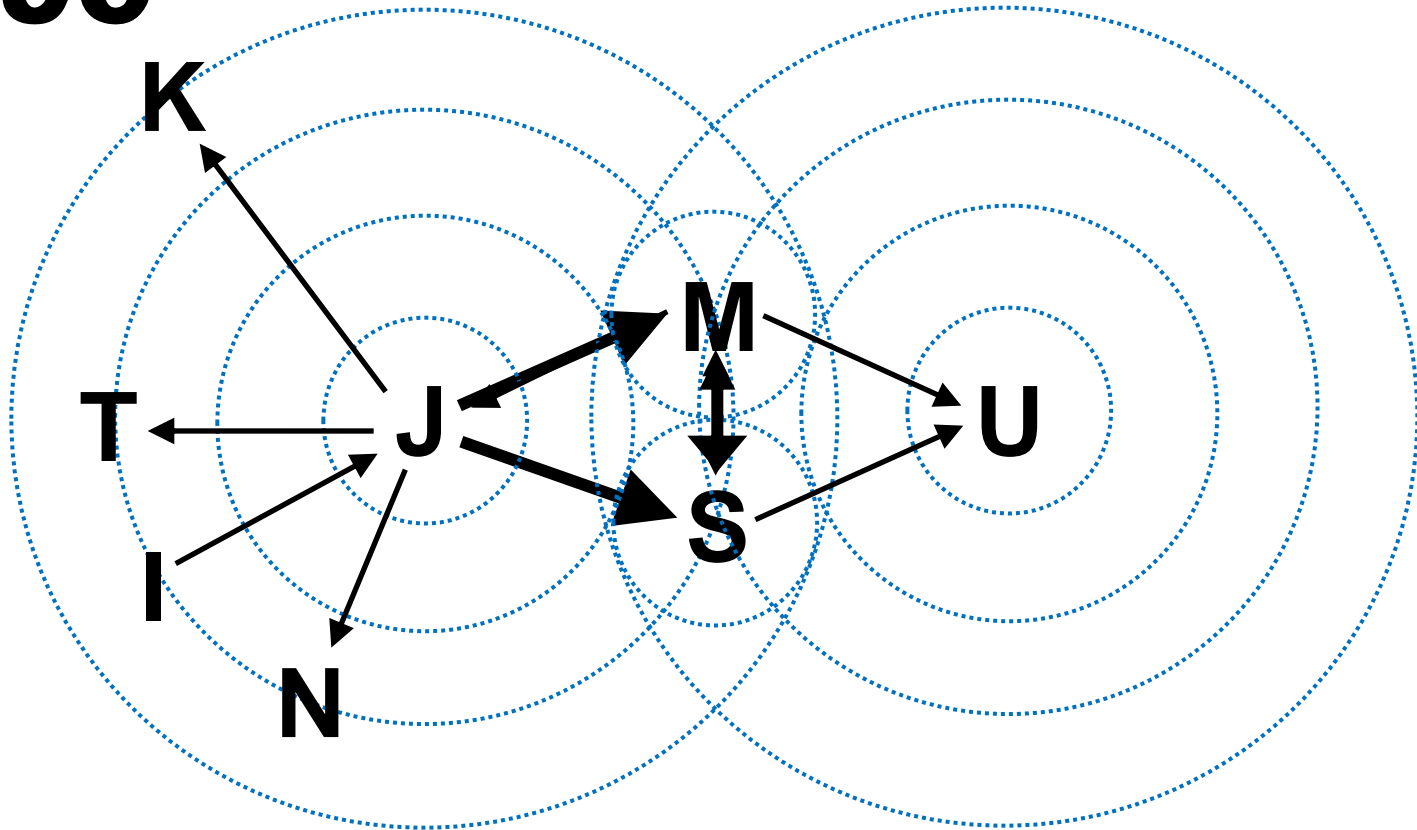

**C**: China, **I**: Indonesia, **J**: Japan, **K**: Korea,  
**M**: Malaysia, **N**: Taiwan, **P**: The Philippines,  
**S**: Singapore, **T**: Thailand, **U**: The USA

# 2000

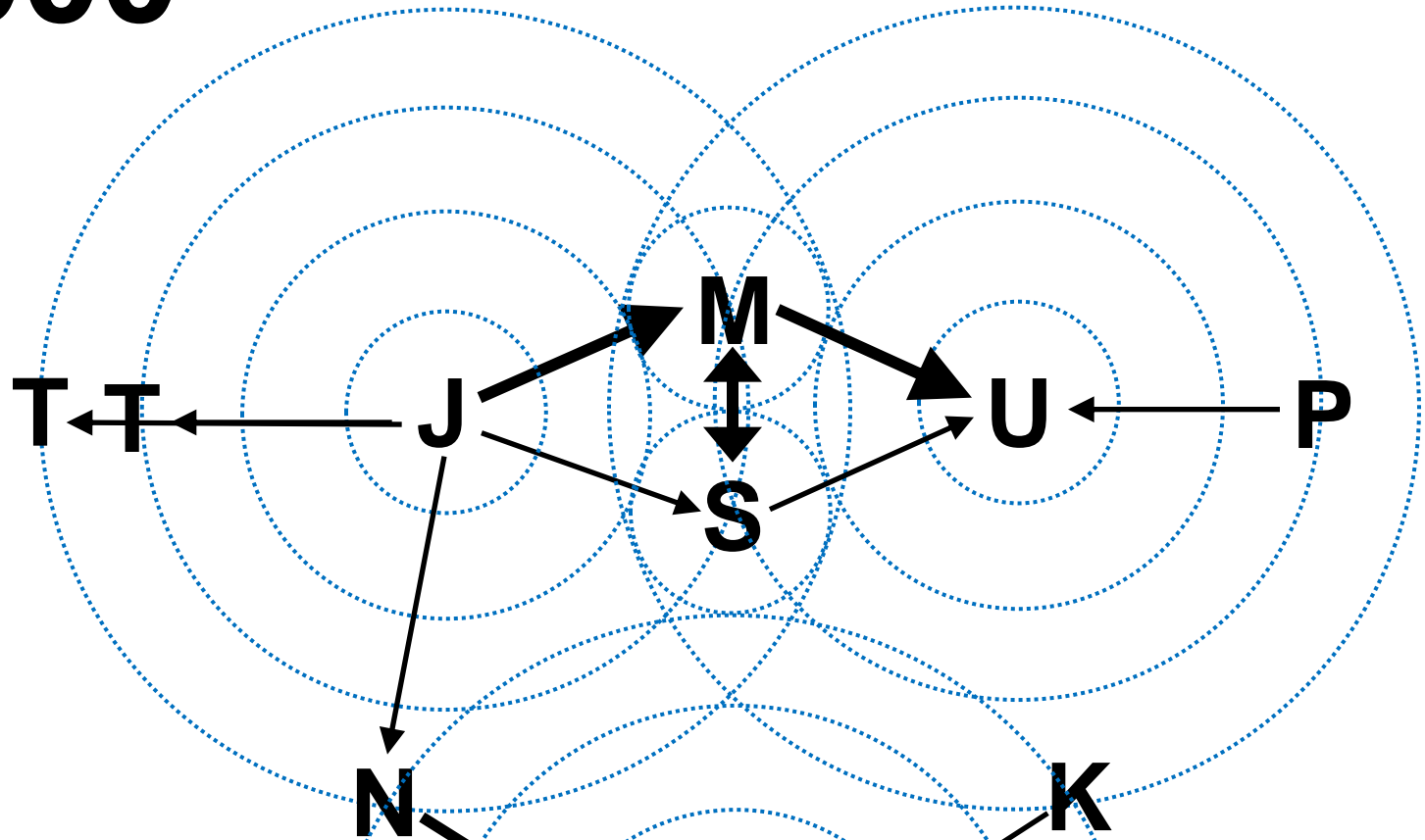

**C**: China, **I**: Indonesia, **J**: Japan, **K**: Korea,  
**M**: Malaysia, **N**: Taiwan, **P**: The Philippines,  
**S**: Singapore, **T**: Thailand, **U**: The USA

# 2005

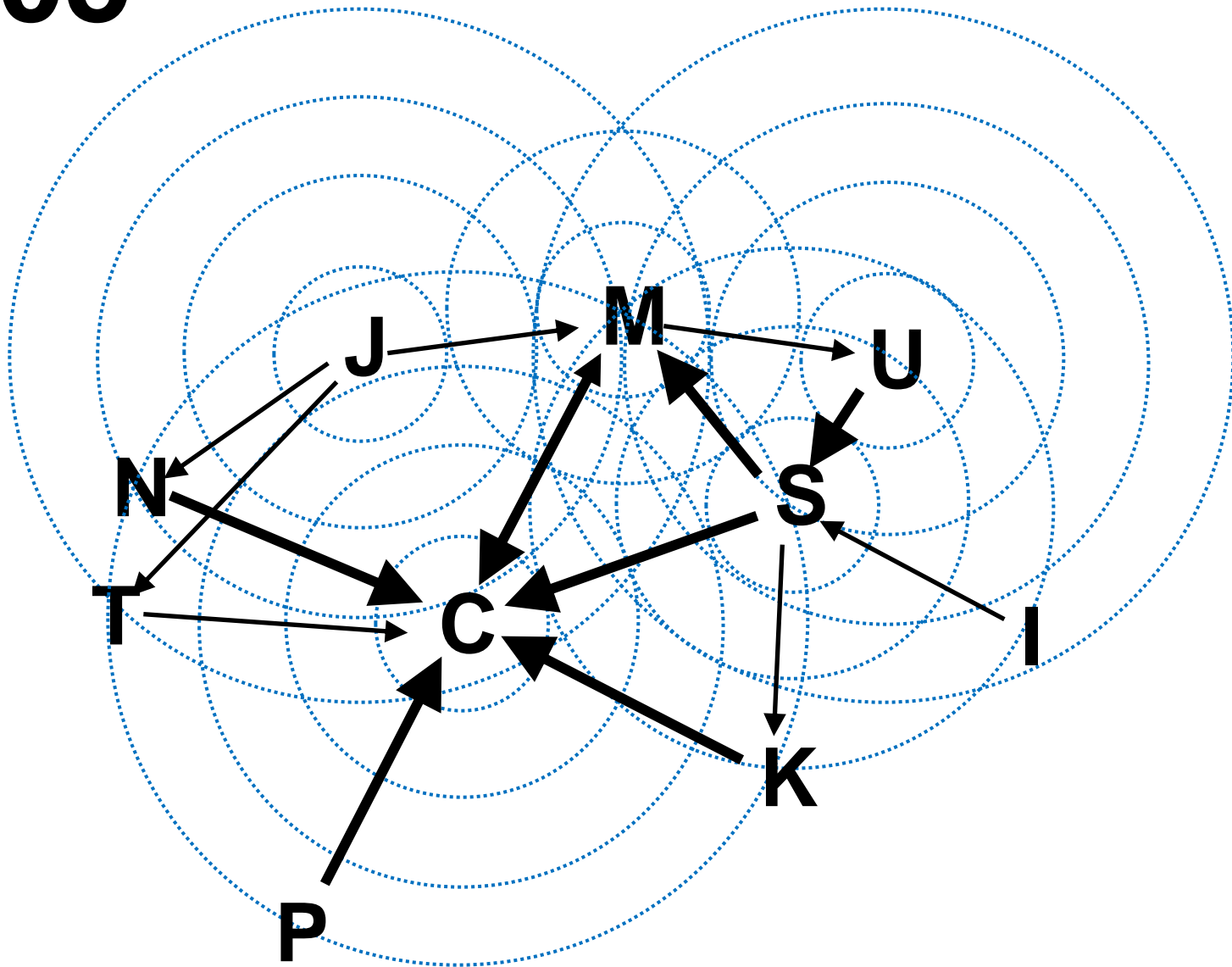

# 2005

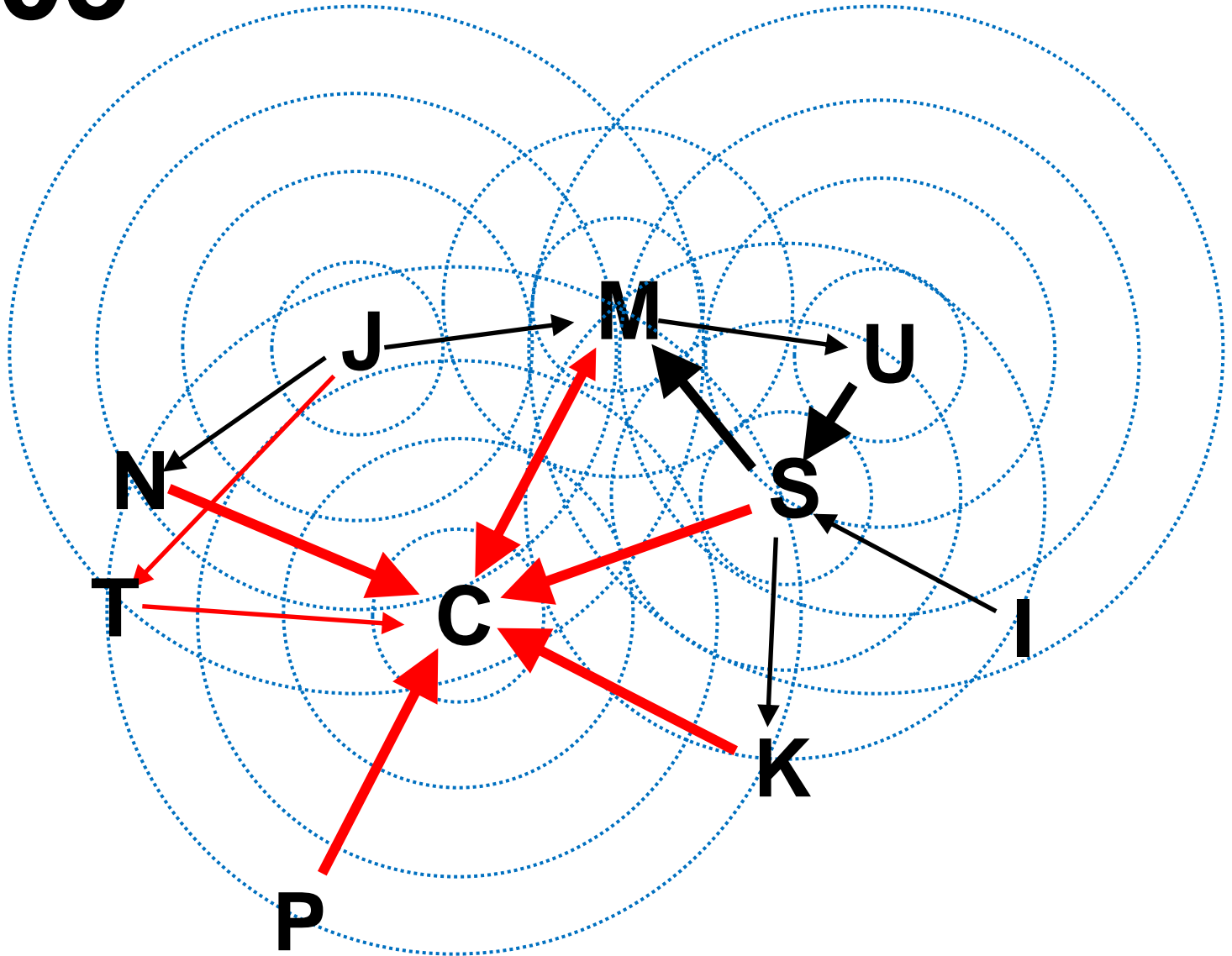

# A new measurement of international trade



# *Tri-polar Trade through China*

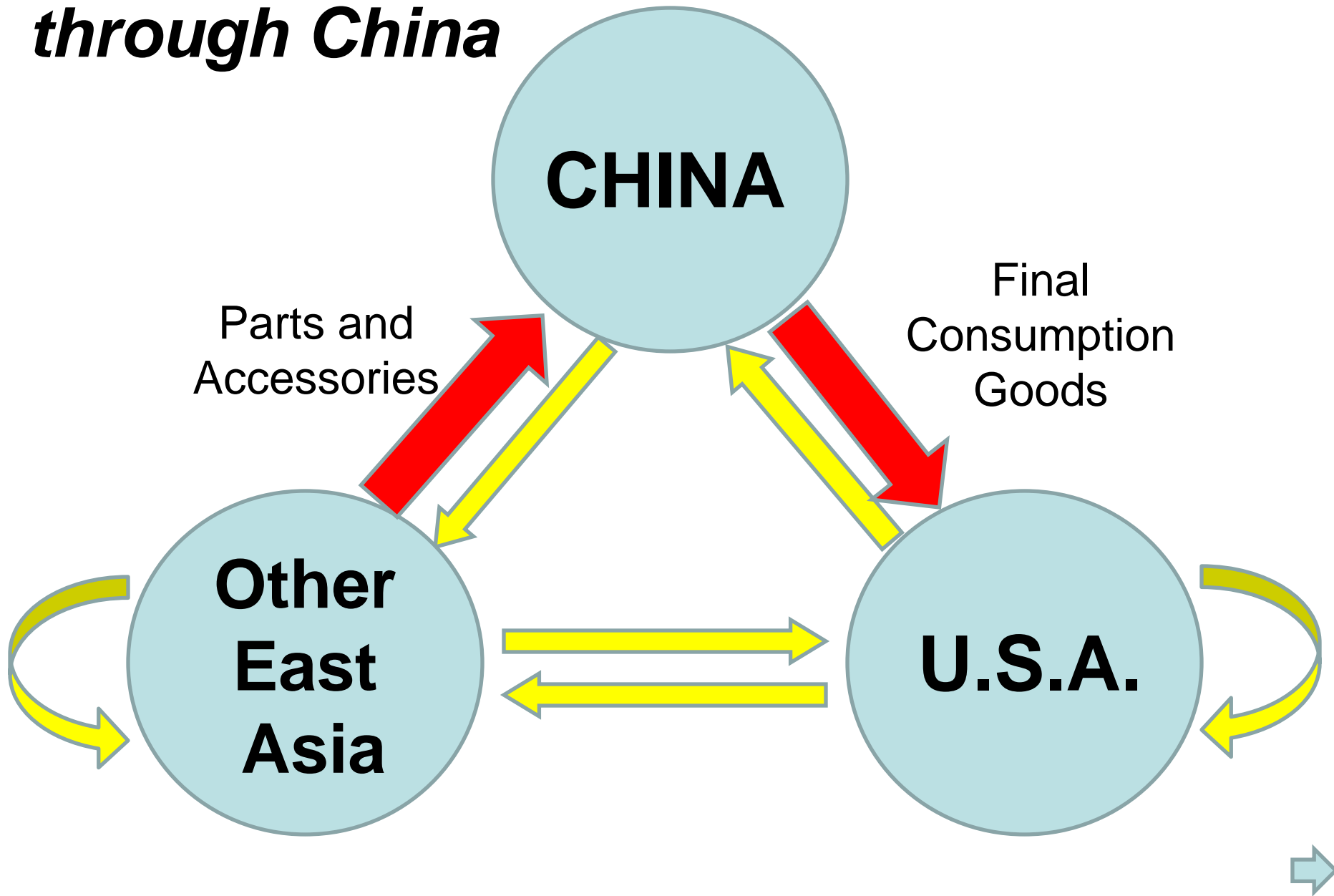

# *Tri-polar Trade through China*

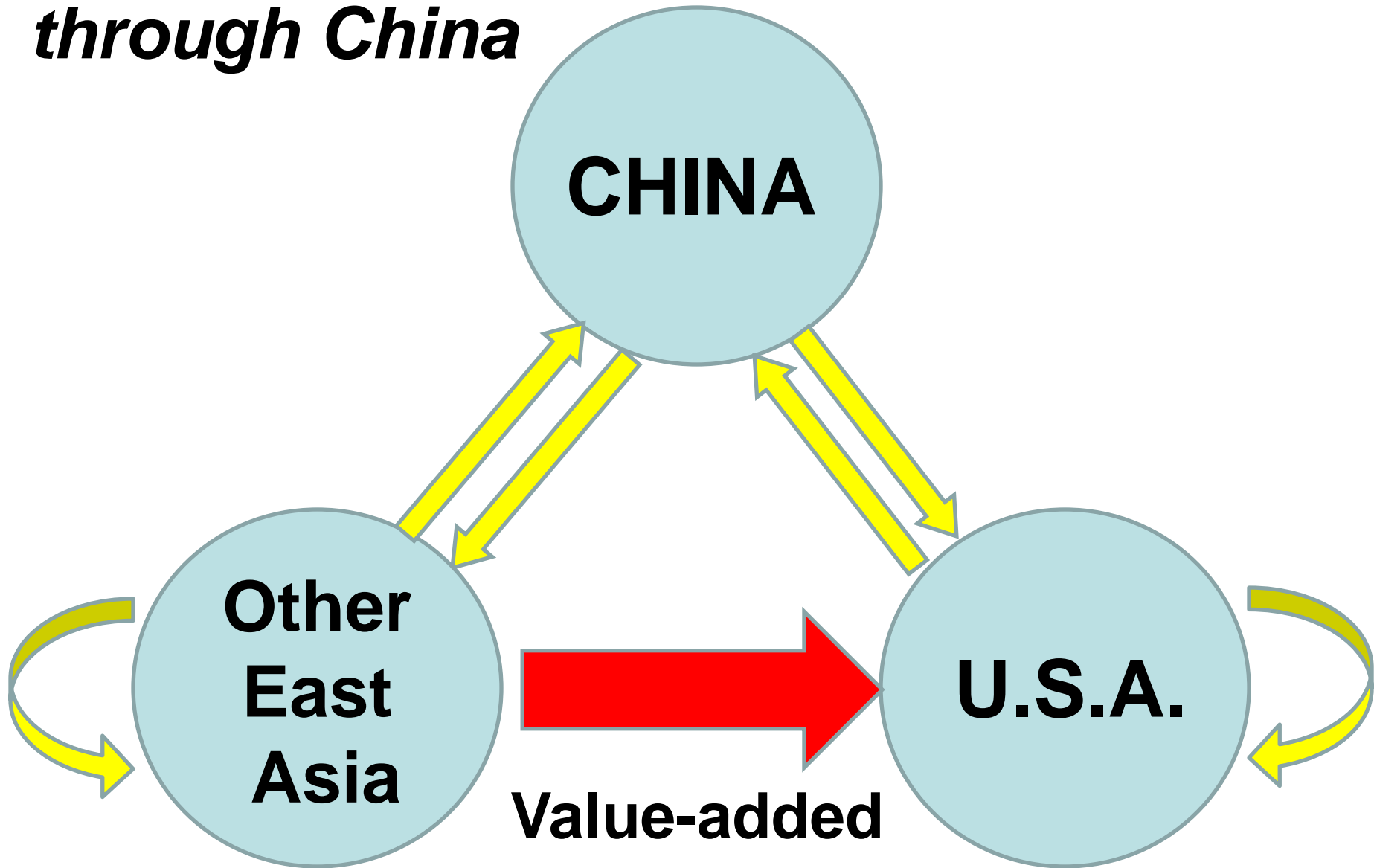

# Trade in ~~value-added~~ services

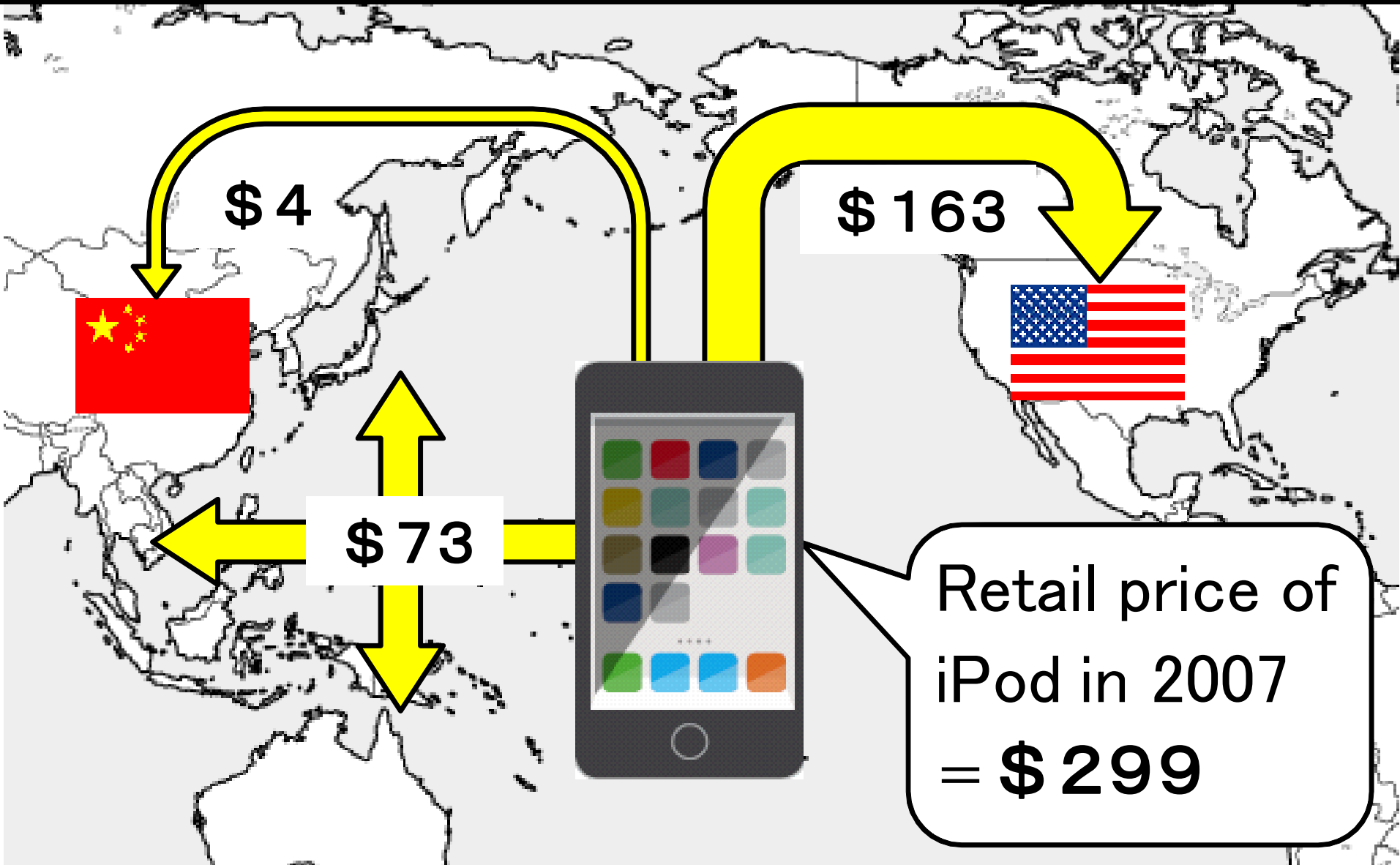

Source: Varian, Hal R. "An iPod Has Global Value. Ask the (Many) Countries That Make It." The New York Times, June 28, 2007.

# Production spillover (car industry)

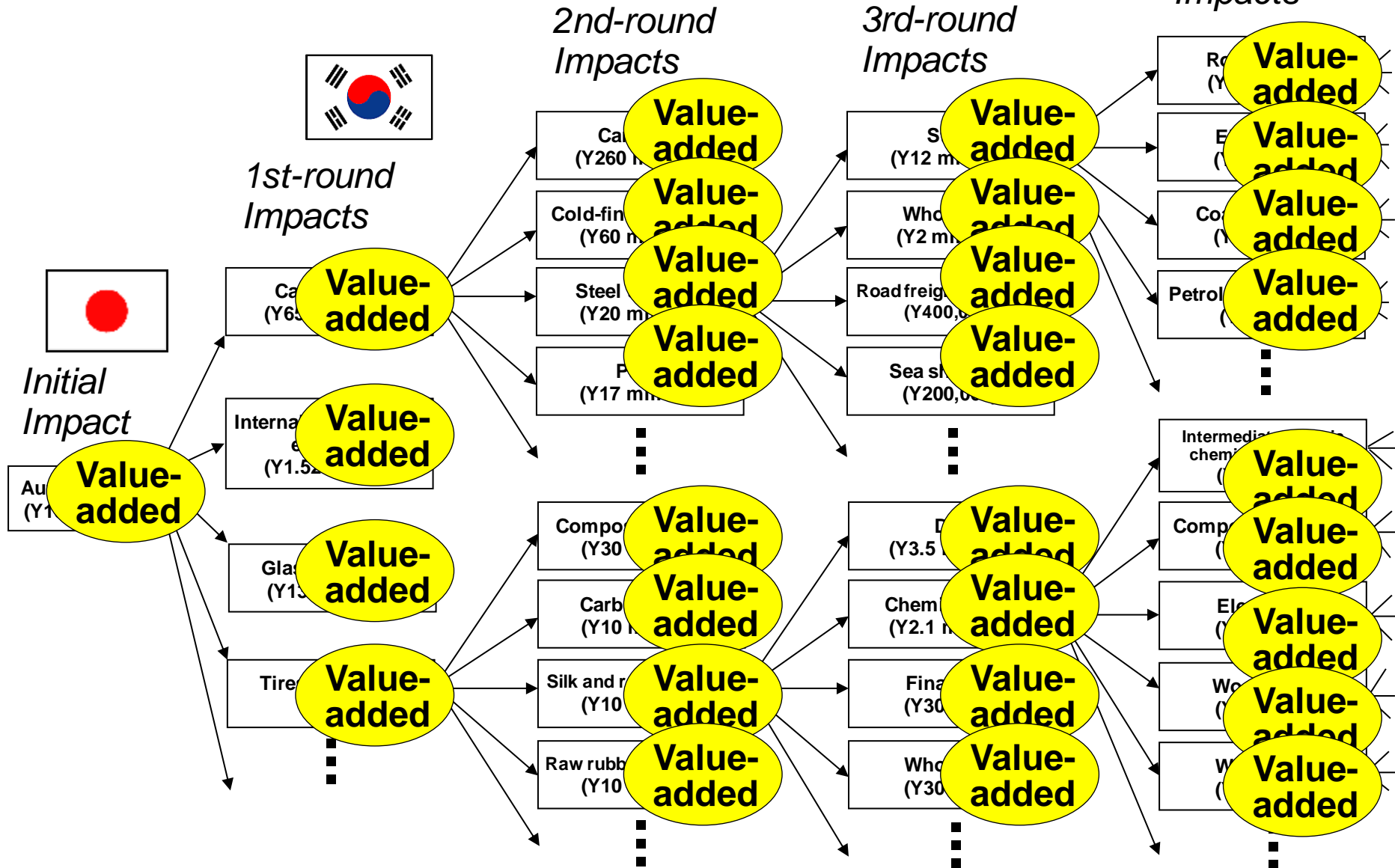
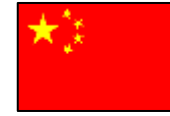

# Main Data

The Asian International Input-Output Table,  
constructed by  
Institute of Developing Economies JETRO

Reference years: 1985, 1990, 1995, 2000, 2008(update)

Country coverage: China, Japan, Korea, Taiwan, Singapore,  
Malaysia, Thailand, The Philippines, Indonesia, The U.S.A.

Industrial sector classification: 76 sectors for most detailed.

# A schematic image of the Asian International Input-Output Table

		Intermediate Demand (A)										Final Demand (F)										Export (L)					Statistical Discrepancy (QX)	Total Outputs (XX)
		Indonesia (AI)	Malaysia (AM)	Philippines (AP)	Singapore (AS)	Thailand (AT)	China (AC)	Taiwan (AN)	Korea (AK)	Japan (AJ)	U.S.A. (AU)	Indonesia (FI)	Malaysia (FM)	Philippines (FP)	Singapore (FS)	Thailand (FT)	China (FC)	Taiwan (FN)	Korea (FK)	Japan (FJ)	U.S.A. (FU)	Export to India (LG)	Export to Hong Kong (LH)	Export to EU (LO)	Export to R.O.W. (LW)			
Indonesia	(AI)	A <sup>II</sup>	A <sup>IM</sup>	A <sup>IP</sup>	A <sup>IS</sup>	A <sup>IT</sup>	A <sup>IC</sup>	A <sup>IN</sup>	A <sup>IK</sup>	A <sup>IJ</sup>	A <sup>IU</sup>	F <sup>II</sup>	F <sup>IM</sup>	F <sup>IP</sup>	F <sup>IS</sup>	F <sup>IT</sup>	F <sup>IC</sup>	F <sup>IN</sup>	F <sup>IK</sup>	F <sup>IJ</sup>	F <sup>IU</sup>	L <sup>IG</sup>	L <sup>IH</sup>	L <sup>IO</sup>	L <sup>IW</sup>	Q <sup>I</sup>	X <sup>I</sup>	
Malaysia	(AM)	A <sup>MI</sup>	A <sup>MM</sup>	A <sup>MP</sup>	A <sup>MS</sup>	A <sup>MT</sup>	A <sup>MC</sup>	A <sup>MN</sup>	A <sup>MK</sup>	A <sup>MJ</sup>	A <sup>MU</sup>	F <sup>MI</sup>	F <sup>MM</sup>	F <sup>MP</sup>	F <sup>MS</sup>	F <sup>MT</sup>	F <sup>MC</sup>	F <sup>MN</sup>	F <sup>MK</sup>	F <sup>MJ</sup>	F <sup>MU</sup>	L <sup>MG</sup>	L <sup>MH</sup>	L <sup>MO</sup>	L <sup>MW</sup>	Q <sup>M</sup>	X <sup>M</sup>	
Philippines	(AP)	A <sup>PI</sup>	A <sup>PM</sup>	A <sup>PP</sup>	A <sup>PS</sup>	A <sup>PT</sup>	A <sup>PC</sup>	A <sup>PN</sup>	A <sup>PK</sup>	A <sup>PJ</sup>	A <sup>PU</sup>	F <sup>PI</sup>	F <sup>PM</sup>	F <sup>PP</sup>	F <sup>PS</sup>	F <sup>PT</sup>	F <sup>PC</sup>	F <sup>PN</sup>	F <sup>PK</sup>	F <sup>PJ</sup>	F <sup>PU</sup>	L <sup>PG</sup>	L <sup>PH</sup>	L <sup>PO</sup>	L <sup>PW</sup>	Q <sup>P</sup>	X <sup>P</sup>	
Singapore	(AS)	A <sup>SI</sup>	A <sup>SM</sup>	A <sup>SP</sup>	A <sup>SS</sup>	A <sup>ST</sup>	A <sup>SC</sup>	A <sup>SN</sup>	A <sup>SK</sup>	A <sup>SJ</sup>	A <sup>SU</sup>	F <sup>SI</sup>	F <sup>SM</sup>	F <sup>SP</sup>	F <sup>SS</sup>	F <sup>ST</sup>	F <sup>SC</sup>	F <sup>SN</sup>	F <sup>SK</sup>	F <sup>SJ</sup>	F <sup>SU</sup>	L <sup>SG</sup>	L <sup>SH</sup>	L <sup>SO</sup>	L <sup>SW</sup>	Q <sup>S</sup>	X <sup>S</sup>	
Thailand	(AT)	A <sup>TI</sup>	A <sup>TM</sup>	A <sup>TP</sup>	A <sup>TS</sup>	A <sup>TT</sup>	A <sup>TC</sup>	A <sup>TN</sup>	A <sup>TK</sup>	A <sup>TJ</sup>	A <sup>TU</sup>	F <sup>TI</sup>	F <sup>TM</sup>	F <sup>TP</sup>	F <sup>TS</sup>	F <sup>TT</sup>	F <sup>TC</sup>	F <sup>TN</sup>	F <sup>TK</sup>	F <sup>TJ</sup>	F <sup>TU</sup>	L <sup>TG</sup>	L <sup>TH</sup>	L <sup>TO</sup>	L <sup>TW</sup>	Q <sup>T</sup>	X <sup>T</sup>	
China	(AC)	A <sup>CI</sup>	A <sup>CM</sup>	A <sup>CP</sup>	A <sup>CS</sup>	A <sup>CT</sup>	A <sup>CC</sup>	A <sup>CN</sup>	A <sup>CK</sup>	A <sup>CJ</sup>	A <sup>CU</sup>	F <sup>CI</sup>	F <sup>CM</sup>	F <sup>CP</sup>	F <sup>CS</sup>	F <sup>CT</sup>	F <sup>CC</sup>	F <sup>CN</sup>	F <sup>CK</sup>	F <sup>CJ</sup>	F <sup>CU</sup>	L <sup>CG</sup>	L <sup>CH</sup>	L <sup>CO</sup>	L <sup>CW</sup>	Q <sup>C</sup>	X <sup>C</sup>	
Taiwan	(AN)	A <sup>NI</sup>	A <sup>NM</sup>	A <sup>NP</sup>	A <sup>NS</sup>	A <sup>NT</sup>	A <sup>NC</sup>	A <sup>NN</sup>	A <sup>NK</sup>	A <sup>NJ</sup>	A <sup>NU</sup>	F <sup>NI</sup>	F <sup>NM</sup>	F <sup>NP</sup>	F <sup>NS</sup>	F <sup>NT</sup>	F <sup>NC</sup>	F <sup>NN</sup>	F <sup>NK</sup>	F <sup>NJ</sup>	F <sup>NU</sup>	L <sup>NG</sup>	L <sup>NH</sup>	L <sup>NO</sup>	L <sup>NW</sup>	Q <sup>N</sup>	X <sup>N</sup>	
Korea	(AK)	A <sup>KI</sup>	A <sup>KM</sup>	A <sup>KP</sup>	A <sup>KS</sup>	A <sup>KT</sup>	A <sup>KC</sup>	A <sup>KN</sup>	A <sup>KK</sup>	A <sup>KJ</sup>	A <sup>KU</sup>	F <sup>KI</sup>	F <sup>KM</sup>	F <sup>KP</sup>	F <sup>KS</sup>	F <sup>KT</sup>	F <sup>KC</sup>	F <sup>KN</sup>	F <sup>KK</sup>	F <sup>KJ</sup>	F <sup>KU</sup>	L <sup>KG</sup>	L <sup>KH</sup>	L <sup>KO</sup>	L <sup>KW</sup>	Q <sup>K</sup>	X <sup>K</sup>	
Japan	(AJ)	A <sup>JI</sup>	A <sup>JM</sup>	A <sup>JP</sup>	A <sup>JS</sup>	A <sup>JT</sup>	A <sup>JC</sup>	A <sup>JN</sup>	A <sup>JK</sup>	A <sup>JJ</sup>	A <sup>JU</sup>	F <sup>JI</sup>	F <sup>JM</sup>	F <sup>JP</sup>	F <sup>JS</sup>	F <sup>JT</sup>	F <sup>JC</sup>	F <sup>JN</sup>	F <sup>JK</sup>	F <sup>JJ</sup>	F <sup>JU</sup>	L <sup>JG</sup>	L <sup>JH</sup>	L <sup>JO</sup>	L <sup>JW</sup>	Q <sup>J</sup>	X <sup>J</sup>	
U.S.A.	(AU)	A <sup>UI</sup>	A <sup>UM</sup>	A <sup>UP</sup>	A <sup>US</sup>	A <sup>UT</sup>	A <sup>UC</sup>	A <sup>UN</sup>	A <sup>UK</sup>	A <sup>UJ</sup>	A <sup>UU</sup>	F <sup>UI</sup>	F <sup>UM</sup>	F <sup>UP</sup>	F <sup>US</sup>	F <sup>UT</sup>	F <sup>UC</sup>	F <sup>UN</sup>	F <sup>UK</sup>	F <sup>UJ</sup>	F <sup>UU</sup>	L <sup>UG</sup>	L <sup>UH</sup>	L <sup>UO</sup>	L <sup>UW</sup>	Q <sup>U</sup>	X <sup>U</sup>	
Freight and Insurance	(BF)	BA <sup>I</sup>	BA <sup>M</sup>	BA <sup>P</sup>	BA <sup>S</sup>	BA <sup>T</sup>	BA <sup>C</sup>	BA <sup>N</sup>	BA <sup>K</sup>	BA <sup>J</sup>	BA <sup>U</sup>	BF <sup>I</sup>	BF <sup>M</sup>	BF <sup>P</sup>	BF <sup>S</sup>	BF <sup>T</sup>	BF <sup>C</sup>	BF <sup>N</sup>	BF <sup>K</sup>	BF <sup>J</sup>	BF <sup>U</sup>							
Import from India	(CG)	AG <sup>I</sup>	AG <sup>M</sup>	AG <sup>P</sup>	AG <sup>S</sup>	AG <sup>T</sup>	AG <sup>C</sup>	AG <sup>N</sup>	AG <sup>K</sup>	AG <sup>J</sup>	AG <sup>U</sup>	FG <sup>I</sup>	FG <sup>M</sup>	FG <sup>P</sup>	FG <sup>S</sup>	FG <sup>T</sup>	FG <sup>C</sup>	FG <sup>N</sup>	FG <sup>K</sup>	FG <sup>J</sup>	FG <sup>U</sup>							
Import from Hong Kong	(CH)	A <sup>HI</sup>	A <sup>HM</sup>	A <sup>HP</sup>	A <sup>HS</sup>	A <sup>HT</sup>	A <sup>HC</sup>	A <sup>HN</sup>	A <sup>HK</sup>	A <sup>HJ</sup>	A <sup>HU</sup>	F <sup>HI</sup>	F <sup>HM</sup>	F <sup>HP</sup>	F <sup>HS</sup>	F <sup>HT</sup>	F <sup>HC</sup>	F <sup>HN</sup>	F <sup>HK</sup>	F <sup>HJ</sup>	F <sup>HU</sup>							
Import from EU	(CO)	A <sup>OI</sup>	A <sup>OM</sup>	A <sup>OP</sup>	A <sup>OS</sup>	A <sup>OT</sup>	A <sup>OC</sup>	A <sup>ON</sup>	A <sup>OK</sup>	A <sup>OJ</sup>	A <sup>OU</sup>	F <sup>OI</sup>	F <sup>OM</sup>	F <sup>OP</sup>	F <sup>OS</sup>	F <sup>OT</sup>	F <sup>OC</sup>	F <sup>ON</sup>	F <sup>OK</sup>	F <sup>OJ</sup>	F <sup>OU</sup>							
Import from the R.O.W.	(CW)	A <sup>WI</sup>	A <sup>WM</sup>	A <sup>WP</sup>	A <sup>WS</sup>	A <sup>WT</sup>	A <sup>WC</sup>	A <sup>WN</sup>	A <sup>WK</sup>	A <sup>WJ</sup>	A <sup>WU</sup>	F <sup>WI</sup>	F <sup>WM</sup>	F <sup>WP</sup>	F <sup>WS</sup>	F <sup>WT</sup>	F <sup>WC</sup>	F <sup>WN</sup>	F <sup>WK</sup>	F <sup>WJ</sup>	F <sup>WU</sup>							
Duties and Import Commodity Taxes	(DT)	DA <sup>I</sup>	DA <sup>M</sup>	DA <sup>P</sup>	DA <sup>S</sup>	DA <sup>T</sup>	DA <sup>C</sup>	DA <sup>N</sup>	DA <sup>K</sup>	DA <sup>J</sup>	DA <sup>U</sup>	DF <sup>I</sup>	DF <sup>M</sup>	DF <sup>P</sup>	DF <sup>S</sup>	DF <sup>T</sup>	DF <sup>C</sup>	DF <sup>N</sup>	DF <sup>K</sup>	DF <sup>J</sup>	DF <sup>U</sup>							
Value Added	(VV)	V <sup>I</sup>	V <sup>M</sup>	V <sup>P</sup>	V <sup>S</sup>	V <sup>T</sup>	V <sup>C</sup>	V <sup>N</sup>	V <sup>K</sup>	V <sup>J</sup>	V <sup>U</sup>																	
Total Inputs	(XX)	X <sup>I</sup>	X <sup>M</sup>	X <sup>P</sup>	X <sup>S</sup>	X <sup>T</sup>	X <sup>C</sup>	X <sup>N</sup>	X <sup>K</sup>	X <sup>J</sup>	X <sup>U</sup>																	

\* Each cell of A\*\* and F\*\* represents a matrix of 76 x 76 and 76 x 4 dimension, respectively.

# Production spillover (car industry)

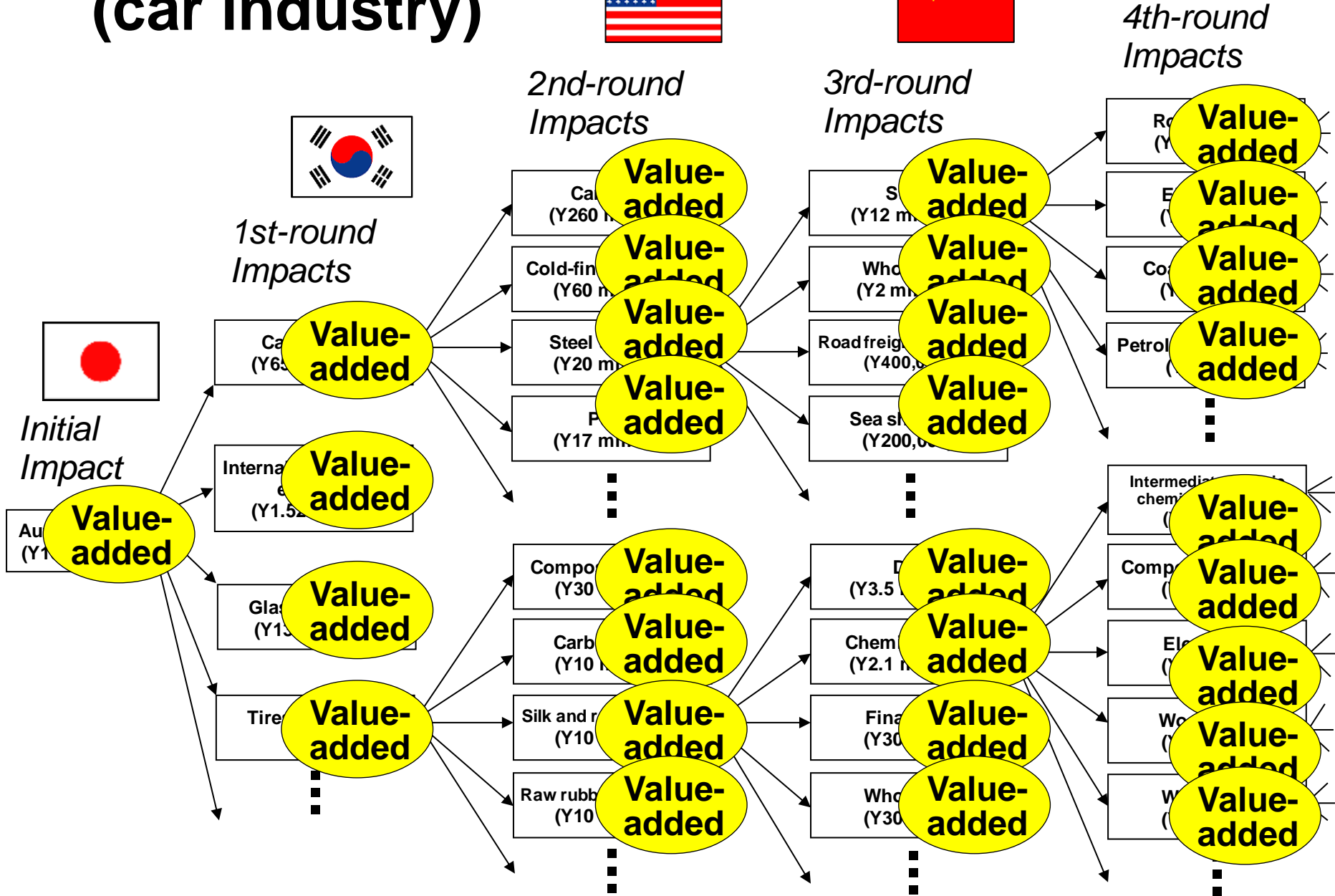
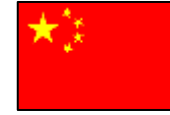



# US trade deficit with China

(billion US\$)

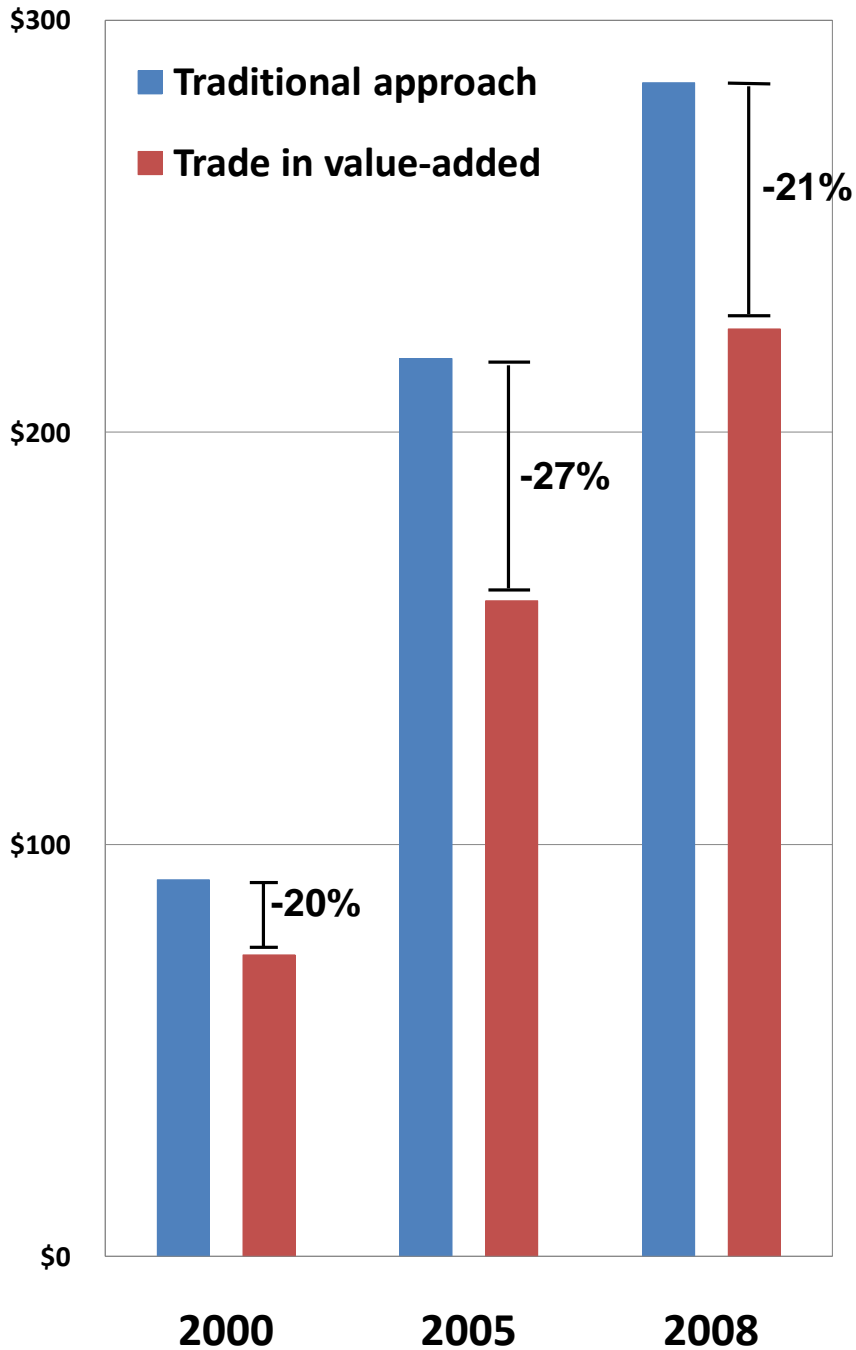

Source: WTO&IDE's calculation based on UN Comtrade

# **Measuring trade in terms of value-added allows us:**

- To provide a more realistic view of bilateral trade in the light of international production sharing;**
- To avoid multiple counting of trade flows when goods are transferred across borders;**
- To univocally identify the origins of imported products, which helps to implement tax/anti-dumping policies.**



WORLD TRADE  
ORGANIZATION

IDE-JETRO

# Trade patterns and global value chains in East Asia:

From trade in goods to trade in tasks



# Thank you !!





# Schematic image of an I-O table

		Intermediate Transaction			Final Demand			Total Output	
		Agri & Mining	Manu- fact'ing	Service	Cons- umption	Invest- ment	Export		Import
Intermediate Transaction	Agri & Mining	8 0 0	1 8 0 0	2 0 0	6 0 0	4 0 0	3 0 0	-100	4 0 0 0
	Manufacturing <sup>1</sup>	6 0 0	6 0 0	5 0 0	0	3 5 0	2 0 0	-250	3 0 0 0
	Service	4 0 0	3 0 0	9 0 0	3 5 0	5 0	0	0	2 0 0 0
Value Added	Wages	8 0 0	2 0 0	2 5 0					
	Profits	2 5 0	5 0	1 0 0					
	Depreciation	1 0 0	3 0	4 0					
	Taxes	5 0	2 0	1 0					
Total Input		4 0 0 0	3 0 0 0	2 0 0 0					

	<b>Agri &amp; Mining</b>	<b>Manu- fact'ing</b>	<b>Service</b>
<b>Agri &amp; Mining</b>	8 0 0	1 8 0 0	2 0 0
<b>Manufacturing</b>	1 6 0 0	6 0 0	5 0 0
<b>Service</b>	4 0 0	3 0 0	9 0 0
<b>Total Output</b>	4 0 0 0	3 0 0 0	2 0 0 0

	Agri & Mining	Manu- fact'ing	Service
Agri & Mining	8 0 0	1 8 0 0	2 0 0
Manufacturing	6 0 0	6 0 0	5 0 0
Service	4 0 0	3 0 0	9 0 0
Total Output	4 0 0 0	3 0 0 0	2 0 0 0

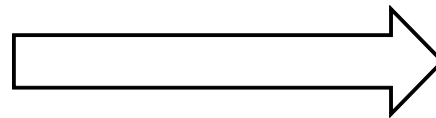

	Agri & Mining	Manu- fact'ing	Service
Agri & Mining	8 0 0	1 8 0 0	2 0 0
Manufacturing	6 0 0	6 0 0	5 0 0
Service	4 0 0	3 0 0	9 0 0
Total Output	4 0 0 0	3 0 0 0	2 0 0 0

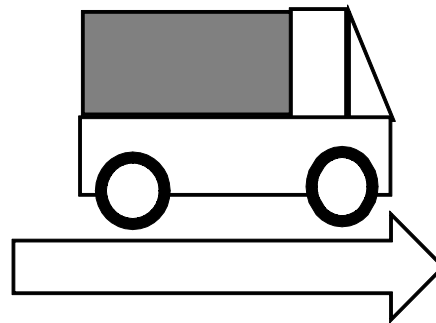



		Intermediate Demand CHINA			Intermediate Demand U.S.A.			Final Demand CHINA		Final Demand U.S.A.		
		Agri- culture	Manu- facturing	Services	Agri- culture	Manu- facturing	Services	Cons- umption	Invest- ment	Cons- umption	Invest- ment	Export to RoW
CHINA	Agriculture	$A^{CC}$			$A^{CU}$			$F^{CC}$		$F^{CU}$		$L^{CW}$
	Manufacturing											
	Services											
U.S.A.	Agriculture	$A^{UC}$			$A^{UU}$			$F^{UC}$		$F^{UU}$		$L^{UW}$
	Manufacturing											
	Services											
REST OF THE WORLD	Agriculture	$A^{WC}$			$A^{WU}$			$F^{WC}$		$F^{WU}$		
	Manufacturing											
	Services											
Value-added	Wages	$V^C$			$V^U$			<p><b>Bilateral IIOT between China and USA</b></p>				
	Profits											
	Depreciation											
	Taxes											

# A schematic image of the Asian International Input-Output Table

		Intermediate Demand (A)										Final Demand (F)										Export (L)					Statistical Discrepancy (QX)	Total Outputs (XX)
		Indonesia (AI)	Malaysia (AM)	Philippines (AP)	Singapore (AS)	Thailand (AT)	China (AC)	Taiwan (AN)	Korea (AK)	Japan (AJ)	U.S.A. (AU)	Indonesia (FI)	Malaysia (FM)	Philippines (FP)	Singapore (FS)	Thailand (FT)	China (FC)	Taiwan (FN)	Korea (FK)	Japan (FJ)	U.S.A. (FU)	Export to India (LG)	Export to Hong Kong (LH)	Export to EU (LO)	Export to R.O.W. (LW)			
Indonesia	(AI)	A <sup>II</sup>	A <sup>IM</sup>	A <sup>IP</sup>	A <sup>IS</sup>	A <sup>IT</sup>	A <sup>IC</sup>	A <sup>IN</sup>	A <sup>IK</sup>	A <sup>IJ</sup>	A <sup>IU</sup>	F <sup>II</sup>	F <sup>IM</sup>	F <sup>IP</sup>	F <sup>IS</sup>	F <sup>IT</sup>	F <sup>IC</sup>	F <sup>IN</sup>	F <sup>IK</sup>	F <sup>IJ</sup>	F <sup>IU</sup>	L <sup>IG</sup>	L <sup>IH</sup>	L <sup>IO</sup>	L <sup>IW</sup>	Q <sup>I</sup>	X <sup>I</sup>	
Malaysia	(AM)	A <sup>MI</sup>	A <sup>MM</sup>	A <sup>MP</sup>	A <sup>MS</sup>	A <sup>MT</sup>	A <sup>MC</sup>	A <sup>MN</sup>	A <sup>MK</sup>	A <sup>MJ</sup>	A <sup>MU</sup>	F <sup>MI</sup>	F <sup>MM</sup>	F <sup>MP</sup>	F <sup>MS</sup>	F <sup>MT</sup>	F <sup>MC</sup>	F <sup>MN</sup>	F <sup>MK</sup>	F <sup>MJ</sup>	F <sup>MU</sup>	L <sup>MG</sup>	L <sup>MH</sup>	L <sup>MO</sup>	L <sup>MW</sup>	Q <sup>M</sup>	X <sup>M</sup>	
Philippines	(AP)	A <sup>PI</sup>	A <sup>PM</sup>	A <sup>PP</sup>	A <sup>PS</sup>	A <sup>PT</sup>	A <sup>PC</sup>	A <sup>PN</sup>	A <sup>PK</sup>	A <sup>PJ</sup>	A <sup>PU</sup>	F <sup>PI</sup>	F <sup>PM</sup>	F <sup>PP</sup>	F <sup>PS</sup>	F <sup>PT</sup>	F <sup>PC</sup>	F <sup>PN</sup>	F <sup>PK</sup>	F <sup>PJ</sup>	F <sup>PU</sup>	L <sup>PG</sup>	L <sup>PH</sup>	L <sup>PO</sup>	L <sup>PW</sup>	Q <sup>P</sup>	X <sup>P</sup>	
Singapore	(AS)	A <sup>SI</sup>	A <sup>SM</sup>	A <sup>SP</sup>	A <sup>SS</sup>	A <sup>ST</sup>	A <sup>SC</sup>	A <sup>SN</sup>	A <sup>SK</sup>	A <sup>SJ</sup>	A <sup>SU</sup>	F <sup>SI</sup>	F <sup>SM</sup>	F <sup>SP</sup>	F <sup>SS</sup>	F <sup>ST</sup>	F <sup>SC</sup>	F <sup>SN</sup>	F <sup>SK</sup>	F <sup>SJ</sup>	F <sup>SU</sup>	L <sup>SG</sup>	L <sup>SH</sup>	L <sup>SO</sup>	L <sup>SW</sup>	Q <sup>S</sup>	X <sup>S</sup>	
Thailand	(AT)	A <sup>TI</sup>	A <sup>TM</sup>	A <sup>TP</sup>	A <sup>TS</sup>	A <sup>TT</sup>	A <sup>TC</sup>	A <sup>TN</sup>	A <sup>TK</sup>	A <sup>TJ</sup>	A <sup>TU</sup>	F <sup>TI</sup>	F <sup>TM</sup>	F <sup>TP</sup>	F <sup>TS</sup>	F <sup>TT</sup>	F <sup>TC</sup>	F <sup>TN</sup>	F <sup>TK</sup>	F <sup>TJ</sup>	F <sup>TU</sup>	L <sup>TG</sup>	L <sup>TH</sup>	L <sup>TO</sup>	L <sup>TW</sup>	Q <sup>T</sup>	X <sup>T</sup>	
China	(AC)	A <sup>CI</sup>	A <sup>CM</sup>	A <sup>CP</sup>	A <sup>CS</sup>	A <sup>CT</sup>	A <sup>CC</sup>	A <sup>CN</sup>	A <sup>CK</sup>	A <sup>CJ</sup>	A <sup>CU</sup>	F <sup>CI</sup>	F <sup>CM</sup>	F <sup>CP</sup>	F <sup>CS</sup>	F <sup>CT</sup>	F <sup>CC</sup>	F <sup>CN</sup>	F <sup>CK</sup>	F <sup>CJ</sup>	F <sup>CU</sup>	L <sup>CG</sup>	L <sup>CH</sup>	L <sup>CO</sup>	L <sup>CW</sup>	Q <sup>C</sup>	X <sup>C</sup>	
Taiwan	(AN)	A <sup>NI</sup>	A <sup>NM</sup>	A <sup>NP</sup>	A <sup>NS</sup>	A <sup>NT</sup>	A <sup>NC</sup>	A <sup>NN</sup>	A <sup>NK</sup>	A <sup>NJ</sup>	A <sup>NU</sup>	F <sup>NI</sup>	F <sup>NM</sup>	F <sup>NP</sup>	F <sup>NS</sup>	F <sup>NT</sup>	F <sup>NC</sup>	F <sup>NN</sup>	F <sup>NK</sup>	F <sup>NJ</sup>	F <sup>NU</sup>	L <sup>NG</sup>	L <sup>NH</sup>	L <sup>NO</sup>	L <sup>NW</sup>	Q <sup>N</sup>	X <sup>N</sup>	
Korea	(AK)	A <sup>KI</sup>	A <sup>KM</sup>	A <sup>KP</sup>	A <sup>KS</sup>	A <sup>KT</sup>	A <sup>KC</sup>	A <sup>KN</sup>	A <sup>KK</sup>	A <sup>KJ</sup>	A <sup>KU</sup>	F <sup>KI</sup>	F <sup>KM</sup>	F <sup>KP</sup>	F <sup>KS</sup>	F <sup>KT</sup>	F <sup>KC</sup>	F <sup>KN</sup>	F <sup>KK</sup>	F <sup>KJ</sup>	F <sup>KU</sup>	L <sup>KG</sup>	L <sup>KH</sup>	L <sup>KO</sup>	L <sup>KW</sup>	Q <sup>K</sup>	X <sup>K</sup>	
Japan	(AJ)	A <sup>JI</sup>	A <sup>JM</sup>	A <sup>JP</sup>	A <sup>JS</sup>	A <sup>JT</sup>	A <sup>JC</sup>	A <sup>JN</sup>	A <sup>JK</sup>	A <sup>JJ</sup>	A <sup>JU</sup>	F <sup>JI</sup>	F <sup>JM</sup>	F <sup>JP</sup>	F <sup>JS</sup>	F <sup>JT</sup>	F <sup>JC</sup>	F <sup>JN</sup>	F <sup>JK</sup>	F <sup>JJ</sup>	F <sup>JU</sup>	L <sup>JG</sup>	L <sup>JH</sup>	L <sup>JO</sup>	L <sup>JW</sup>	Q <sup>J</sup>	X <sup>J</sup>	
U.S.A.	(AU)	A <sup>UI</sup>	A <sup>UM</sup>	A <sup>UP</sup>	A <sup>US</sup>	A <sup>UT</sup>	A <sup>UC</sup>	A <sup>UN</sup>	A <sup>UK</sup>	A <sup>UJ</sup>	A <sup>UU</sup>	F <sup>UI</sup>	F <sup>UM</sup>	F <sup>UP</sup>	F <sup>US</sup>	F <sup>UT</sup>	F <sup>UC</sup>	F <sup>UN</sup>	F <sup>UK</sup>	F <sup>UJ</sup>	F <sup>UU</sup>	L <sup>UG</sup>	L <sup>UH</sup>	L <sup>UO</sup>	L <sup>UW</sup>	Q <sup>U</sup>	X <sup>U</sup>	
Freight and Insurance	(BF)	BA <sup>I</sup>	BA <sup>M</sup>	BA <sup>P</sup>	BA <sup>S</sup>	BA <sup>T</sup>	BA <sup>C</sup>	BA <sup>N</sup>	BA <sup>K</sup>	BA <sup>J</sup>	BA <sup>U</sup>	BF <sup>I</sup>	BF <sup>M</sup>	BF <sup>P</sup>	BF <sup>S</sup>	BF <sup>T</sup>	BF <sup>C</sup>	BF <sup>N</sup>	BF <sup>K</sup>	BF <sup>J</sup>	BF <sup>U</sup>							
Import from India	(CG)	A <sup>GI</sup>	A <sup>GM</sup>	A <sup>GP</sup>	A <sup>GS</sup>	A <sup>GT</sup>	A <sup>GC</sup>	A <sup>GN</sup>	A <sup>GK</sup>	A <sup>GJ</sup>	A <sup>GU</sup>	F <sup>GI</sup>	F <sup>GM</sup>	F <sup>GP</sup>	F <sup>GS</sup>	F <sup>GT</sup>	F <sup>GC</sup>	F <sup>GN</sup>	F <sup>GK</sup>	F <sup>GJ</sup>	F <sup>GU</sup>							
Import from Hong Kong	(CH)	A <sup>HI</sup>	A <sup>HM</sup>	A <sup>HP</sup>	A <sup>HS</sup>	A <sup>HT</sup>	A <sup>HC</sup>	A <sup>HN</sup>	A <sup>HK</sup>	A <sup>HJ</sup>	A <sup>HU</sup>	F <sup>HI</sup>	F <sup>HM</sup>	F <sup>HP</sup>	F <sup>HS</sup>	F <sup>HT</sup>	F <sup>HC</sup>	F <sup>HN</sup>	F <sup>HK</sup>	F <sup>HJ</sup>	F <sup>HU</sup>							
Import from EU	(CO)	A <sup>OI</sup>	A <sup>OM</sup>	A <sup>OP</sup>	A <sup>OS</sup>	A <sup>OT</sup>	A <sup>OC</sup>	A <sup>ON</sup>	A <sup>OK</sup>	A <sup>OJ</sup>	A <sup>OU</sup>	F <sup>OI</sup>	F <sup>OM</sup>	F <sup>OP</sup>	F <sup>OS</sup>	F <sup>OT</sup>	F <sup>OC</sup>	F <sup>ON</sup>	F <sup>OK</sup>	F <sup>OJ</sup>	F <sup>OU</sup>							
Import from the R.O.W.	(CW)	A <sup>WI</sup>	A <sup>WM</sup>	A <sup>WP</sup>	A <sup>WS</sup>	A <sup>WT</sup>	A <sup>WC</sup>	A <sup>WN</sup>	A <sup>WK</sup>	A <sup>WJ</sup>	A <sup>WU</sup>	F <sup>WI</sup>	F <sup>WM</sup>	F <sup>WP</sup>	F <sup>WS</sup>	F <sup>WT</sup>	F <sup>WC</sup>	F <sup>WN</sup>	F <sup>WK</sup>	F <sup>WJ</sup>	F <sup>WU</sup>							
Duties and Import Commodity Taxes	(DT)	DA <sup>I</sup>	DA <sup>M</sup>	DA <sup>P</sup>	DA <sup>S</sup>	DA <sup>T</sup>	DA <sup>C</sup>	DA <sup>N</sup>	DA <sup>K</sup>	DA <sup>J</sup>	DA <sup>U</sup>	DF <sup>I</sup>	DF <sup>M</sup>	DF <sup>P</sup>	DF <sup>S</sup>	DF <sup>T</sup>	DF <sup>C</sup>	DF <sup>N</sup>	DF <sup>K</sup>	DF <sup>J</sup>	DF <sup>U</sup>							
Value Added	(VV)	V <sup>I</sup>	V <sup>M</sup>	V <sup>P</sup>	V <sup>S</sup>	V <sup>T</sup>	V <sup>C</sup>	V <sup>N</sup>	V <sup>K</sup>	V <sup>J</sup>	V <sup>U</sup>																	
Total Inputs	(XX)	X <sup>I</sup>	X <sup>M</sup>	X <sup>P</sup>	X <sup>S</sup>	X <sup>T</sup>	X <sup>C</sup>	X <sup>N</sup>	X <sup>K</sup>	X <sup>J</sup>	X <sup>U</sup>																	

\* Each cell of A\*\* and F\*\* represents a matrix of 76 x 76 and 76 x 4 dimension, respectively.

# Production spillover (car industry)

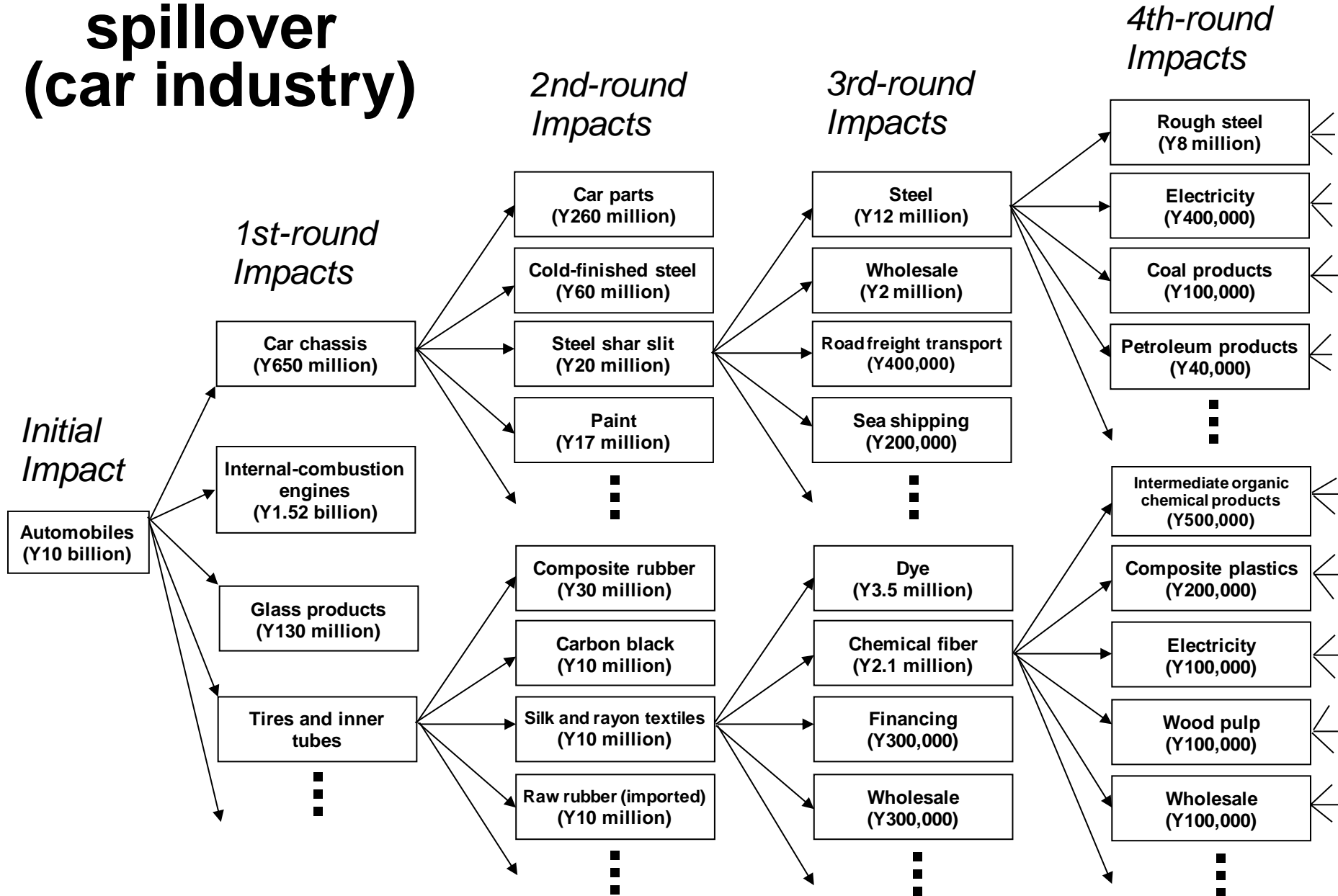

# Strength of Linkage

$$= \{ (l_{ij} - \delta_{ij}) + (g_{ij} - \delta_{ij}) \} / 2$$

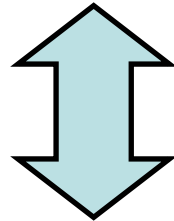

# Length of Linkage

→ Fragmentation level of production process



**Industry A**  
→ **Industry E**

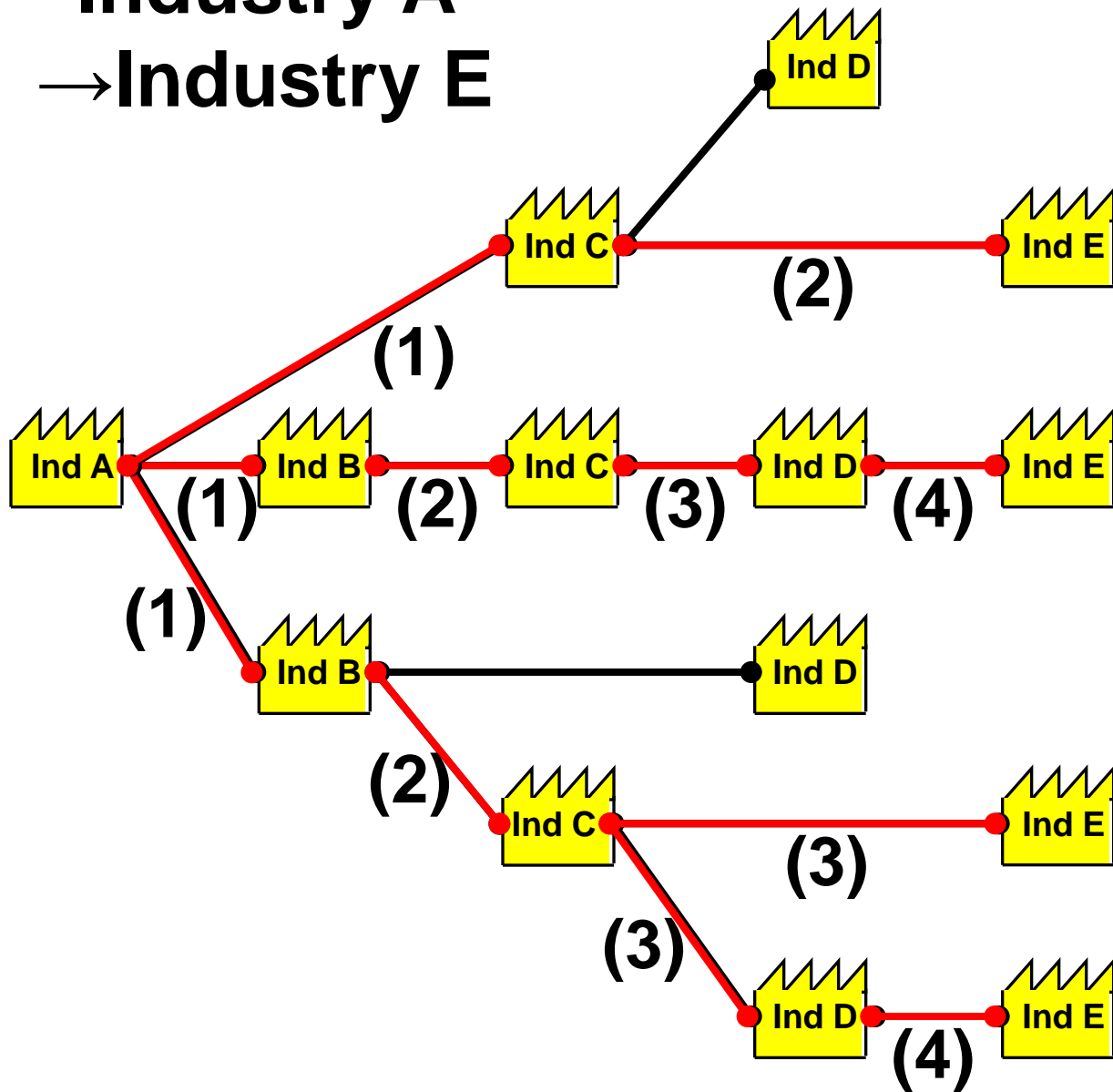

Industry A  
→ Industry E

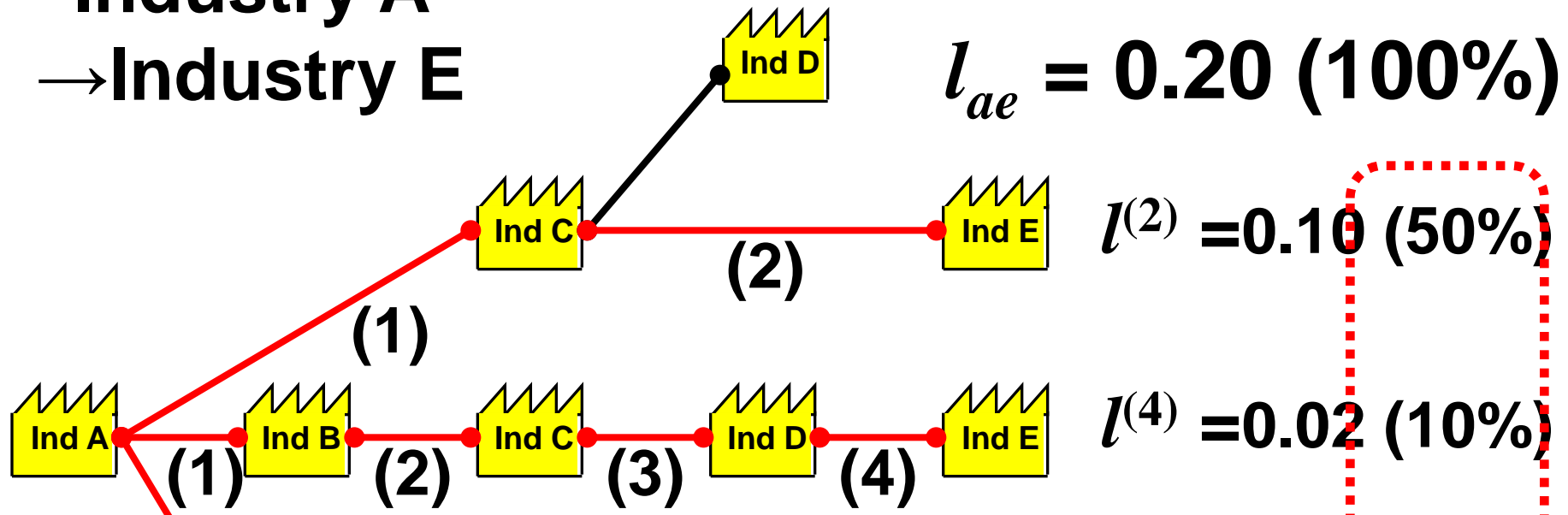

Weighted average of the number of production stages in a supply chain.

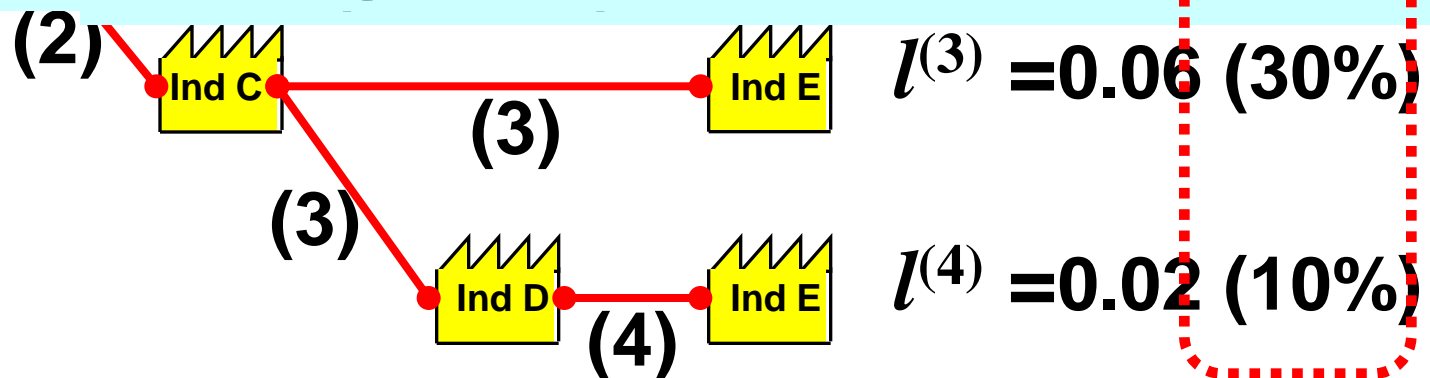

# Trade in value-added and its measurement

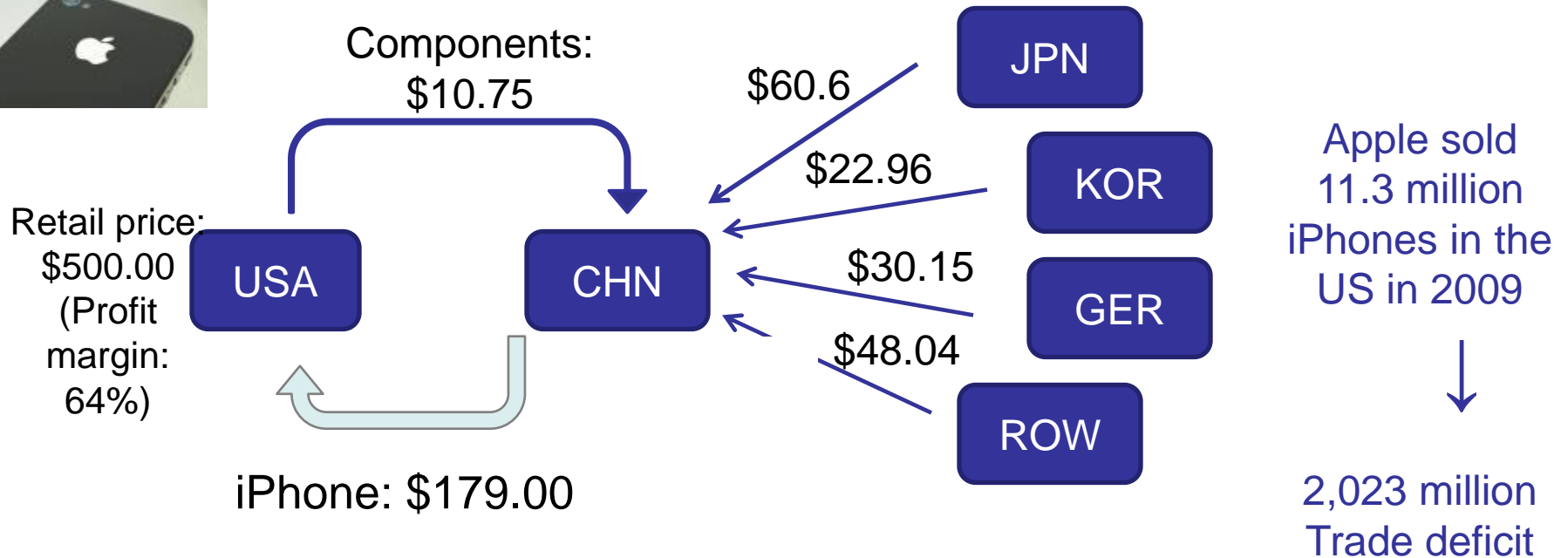

# 2009 US trade balance in iPhones (in millions of US\$)

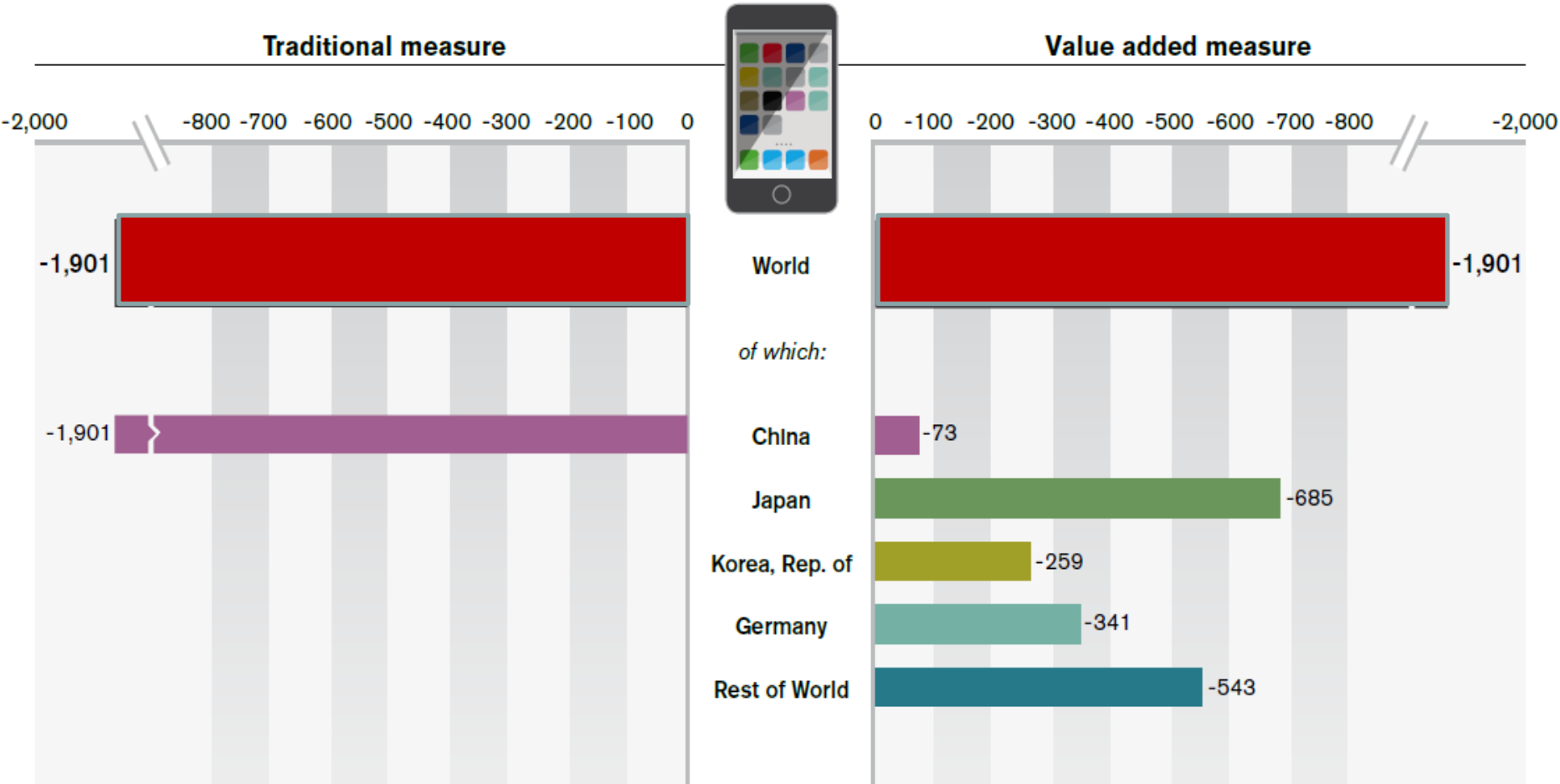

Source: WTO-IDE-JETRO (2011)



# How to measure TVA

Country R's export of  
value-added to country S:

$$VA^{RS} = V^R \cdot L^{RR} \cdot FD^{RS} + V^R \cdot L^{RS} \cdot FD^{SS}$$

=> Trade balance:

$$\sum_S VA^{RS} - \sum_S VA^{SR}$$

# Dreamliner is made in ???

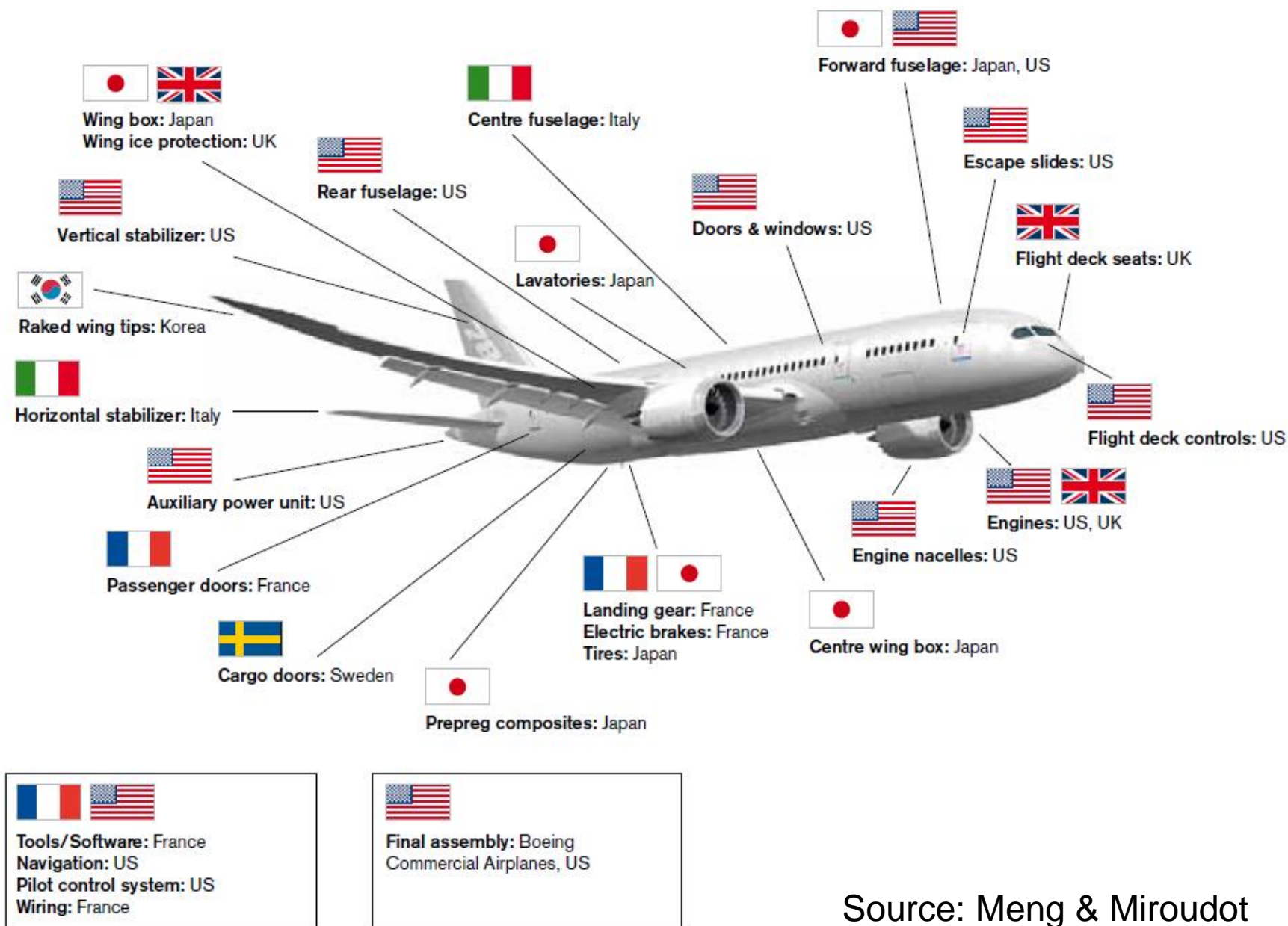

Source: Meng & Miroudot

# Main approaches for measuring Global Value Chains

- Supply chain analysis using firm-level micro data (e.g. Apple, Toyota)
- Structural analysis of trade flows using foreign trade statistics
- International input-output analysis

